

EDCON-COMPONENTS



Specifications

Switch Rating:	2A/36VDC
Contact Configuration:	1NO
Operating Type:	Momentary
IP-Degree:	IP65 / IK08
Crust Material:	Look order Code
Terminal Type:	Look order Code
Switching:	ON (Momentary)
Contact Resistance:	≤ 50mΩ
Insulation Resistance:	≥ 1000MΩ
Dielectric Strength:	2000VAC
Operating Temperature:	. -20°C ~ +55°C
Mechanical Life:	500.000 cycles
Electrical Life:	50.000 cycles
Panel Thickness:	1 ~ 6mm
Nut Torque:	5 ~ 14Nm
Operating Pressure:	About 5N
Operating Distance:	About 1,5Nm
Operating Stroke:	About 2,0mm

Material

Contact:	Silver Alloy
Button:	Look order Code
Body:	Look order Code
Base:	PA66
ROHS:	Made by Order-Code

Drawing

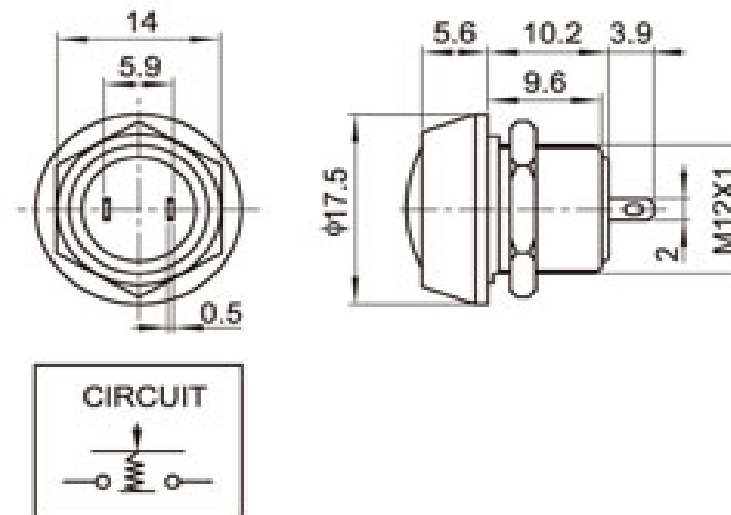

12MM Anti-Vandal-Switch

Part No.: **Q36055-**

Customer:

DRW:	Jason	CHKD	Wilson	MATL:	Wilson	TOLERANCE	Mason	DATE	18.06.2017
APPD:	Schumi			FINISH	Jamy		Sheet No.	1 from 3	

EDCON-COMPONENTS



Visual Effect of Surface



Nickel - plated brass
(Satin surface)



Stainless steel (Spiral surface)



Gold - plated brass (Satin surface)



G=Gray



B=Black



W=White

Engraving Options

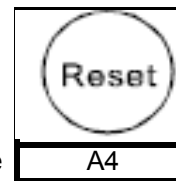

Order Code

A4

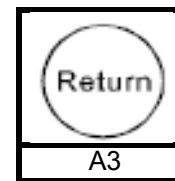

A3

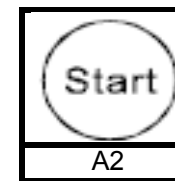

A2

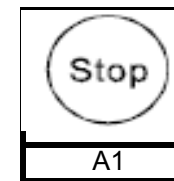

A1

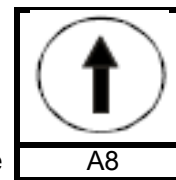

Order Code

A8

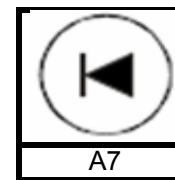

A7

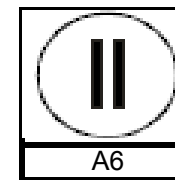

A6

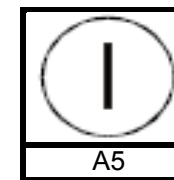

A5

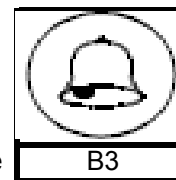

Order Code

B3

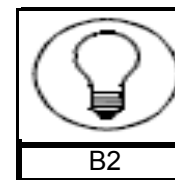

B2

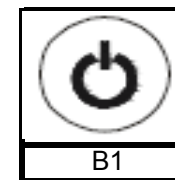

B1

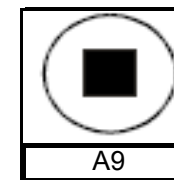

A9

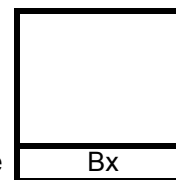

Order Code

Bx

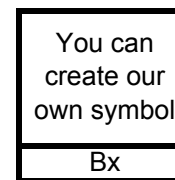

Bx

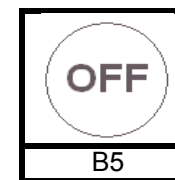

B5

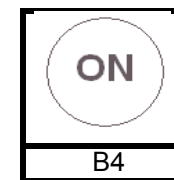

B4

12MM Anti-Vandal-Switch

Part No.: **Q36055-**

DRW:	Jason	CHKD	Wilson	MATL:	Wilson	TOLERANCE	Mason	DATE	18.06.2017	Customer:
APPD:	Schumi			FINISH	Jamy		Sheet No.		2 from 3	

www.edcon-components.com

email: info@edcon-components.com

EDCON-COMPONENTS



Ordering Information

Serie	Front Shape	Contact Structure	Lamp Type	Connect Type	Knob Color	Lamp Voltage	Crust Material	Engraving Options	ROHS	Packing Style
Q36055-	B	10	N	2	Y	0	N	XX	R	N

	10= 1NO	N= no Function	1= Solder Lug 2,0x0,4mm		0= without	S= Stainless Steel	XX= w/o other Look Order Code Engraving Options	R= ROHS Conform	N= White Carton
B= Domed				G= Gray		N= Nickel Plated Brass			
				B= Black		G= Gold Plated Brass			
				W= White					
				O= Orange					
				B= Blue					
				G= Green					
				Y= Yellow					
				R= Red					

12MM Anti-Vandal-Switch	
Part No.:	Q36055-
Customer:	

DRW:	Jason	CHKD	Wilson	MATL:	Wilson	TOLERANCE	Mason	DATE	18.06.2017
APPD:	Schumi			FINISH	Jamy		Sheet No.	3 from 3	