

EDCON-COMPONENTS



Specifications

Switch Rating:	2A/36VDC
Contact Configuration:	1NO
Operating Type:	Momentary
IP-Degree:	IP65 / IK08
Crust Material:	Look order Code
Terminal Type:	Look order Code
Switching:	ON (Momentary)
Contact Resistance:	≤ 50mΩ
Insulation Resistance:	≥ 1000MΩ
Dielectric Strength:	2000VAC
Operating Temperature:	. -20°C ~ +55°C
Mechanical Life:	500.000 cycles
Electrical Life:	50.000 cycles
Panel Thickness:	1 ~ 6mm
Nut Torque:	5 ~ 14Nm
Operating Pressure:	About 5N
Operating Distance:	About 1,5Nm
Operating Stroke:	About 2,0mm

Drawing

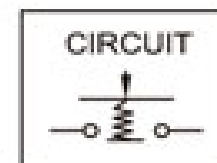
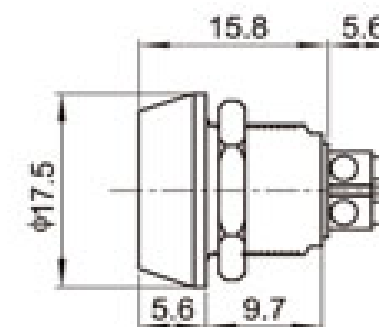
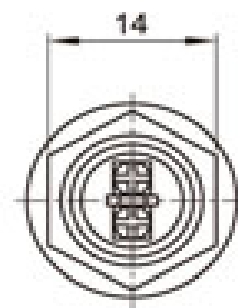

Material

Contact:	Silver Alloy
Button:	Look order Code
Body:	Look order Code
Base:	PA66
ROHS:	Made by Order-Code

12MM Anti-Vandal-Switch

Part No.: **Q36051-**

Customer:

DRW:	Jason	CHKD	Wilson	MATL:	Wilson	TOLERANCE	Mason	DATE	18.06.2017
APPD:	Schumi			FINISH	Jamy		Sheet No.		1 from 3

EDCON-COMPONENTS



Visual Effect of Surface



Nickel - plated brass
(Satin surface)



Stainless steel (Spiral surface)



Gold - plated brass (Satin surface)



G=Gray



B=Black



W=White

Engraving Options

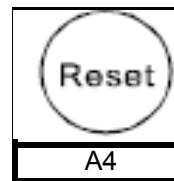

Order Code

A4

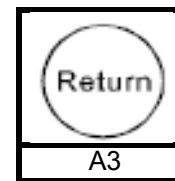

A3

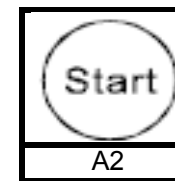

A2

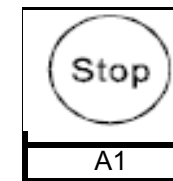

A1

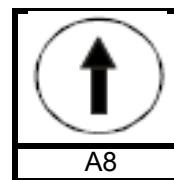

Order Code

A8

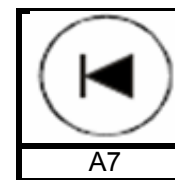

A7

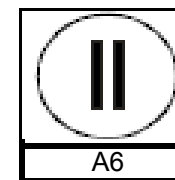

A6

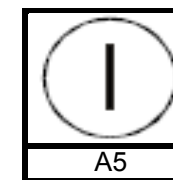

A5

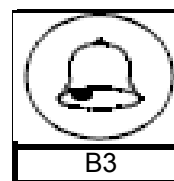

Order Code

B3

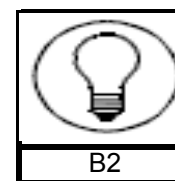

B2

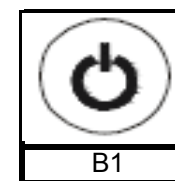

B1

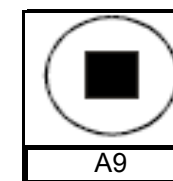

A9

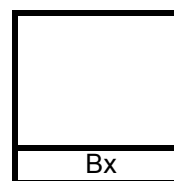

Order Code

Bx

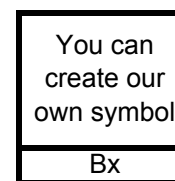

Bx

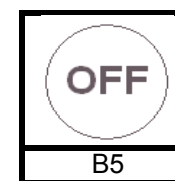

B5

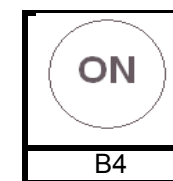

B4

12MM Anti-Vandal-Switch

Part No.: **Q36051-**

DRW:	Jason	CHKD	Wilson	MATL:	Wilson	TOLERANCE	Mason	DATE	18.06.2017	Customer:
APPD:	Schumi			FINISH	Jamy		Sheet No.		2 from 3	

EDCON-COMPONENTS



Ordering Information

Serie	Front Shape	Contact Structure	Lamp Type	Connect Type	Knob Color	Lamp Voltage	Crust Material	Engraving Options	ROHS	Packing Style
Q36051-	F	10	N	2	A	0	N	XX	R	N

	10= 1NO	N= no Function		A= Same us Body	0= without	S= Stainless Steel	XX= w/o other Look Order Code Engraving Options	R= ROHS Conform	N= White Carton
F= Flat			2= Screw Terminal			N= Nickel Plated Brass		N= NON ROHS Conform	I= Individual Packing
						G= Gold Plated Brass			

12MM Anti-Vandal-Switch

Part No.: **Q36051-**

DRW:	Jason	CHKD	Wilson	MATL:	Wilson	TOLERANCE	Mason	DATE	18.06.2017
APPD:	Schumi			FINISH	Jamy		Sheet No.		3 from 3

Customer: