

EDCON-COMPONENTS



Specifications

| | |
|------------------------|-----------------|
| Switch Rating: | 2A/36VDC |
| Contact Configuration: | 1NO |
| Operating Type: | Momentary |
| IP-Degree: | IP65 / IK08 |
| Crust Material: | Look order Code |
| Terminal Type: | Look order Code |
| Switching: | ON (Momentary) |
| Contact Resistance: | ≤ 50mΩ |
| Insulation Resistance: | ≥ 1000MΩ |
| Dielectric Strength: | 2000VAC |
| Operating Temperature: | . -20°C ~ +55°C |
| Mechanical Life: | 500.000 cycles |
| Electrical Life: | 50.000 cycles |
| Panel Thickness: | 1 ~ 6mm |
| Nut Torque: | 5 ~ 14Nm |
| Operating Pressure: | About 5N |
| Operating Distance: | About 1,5Nm |
| Operating Stroke: | About 2,0mm |

Material

| | |
|--------------|--------------------|
| Contact: | Silver Alloy |
| Button: | Look order Code |
| Body: | Look order Code |
| Base: | PA66 |
| ROHS: | Made by Order-Code |

Drawing

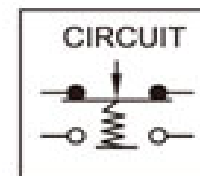
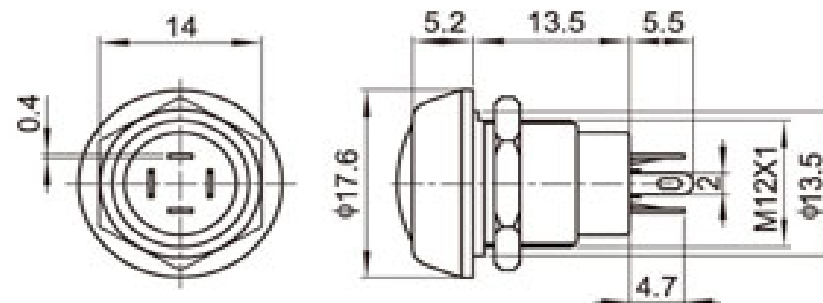

12MM Anti-Vandal-Switch

Part No.: **Q36049-**

Customer:

| | | | | | | | | | |
|-------|--------|------|--------|--------|--------|-----------|-----------|----------|------------|
| DRW: | Jason | CHKD | Wilson | MATL: | Wilson | TOLERANCE | Mason | DATE | 18.06.2017 |
| APPD: | Schumi | | | FINISH | Jamy | | Sheet No. | 1 from 3 | |

EDCON-COMPONENTS



Visual Effect of Surface



Nickel - plated brass
(Satin surface)



Stainless steel (Spiral surface)



Gold - plated brass (Satin surface)

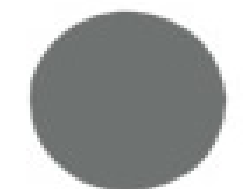

G=Gray



B=Black



W=White

Engraving Options

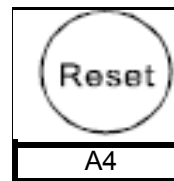

Order Code

A4

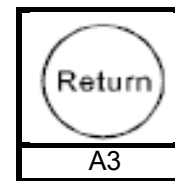

A3

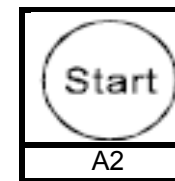

A2

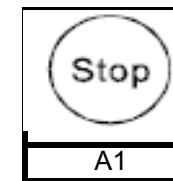

A1

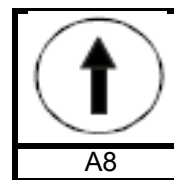

Order Code

A8

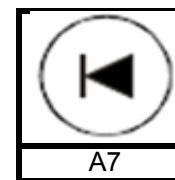

A7

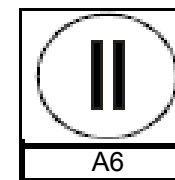

A6

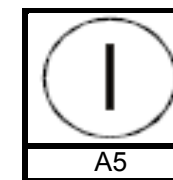

A5

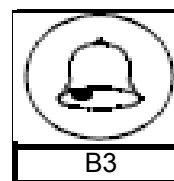

Order Code

B3

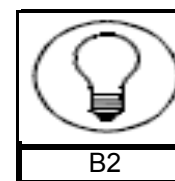

B2

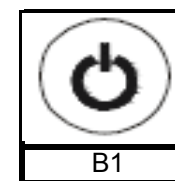

B1

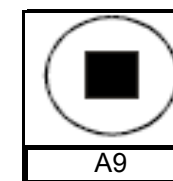

A9

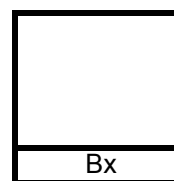

Order Code

Bx

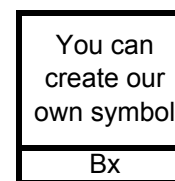

You can create our own symbol

Bx

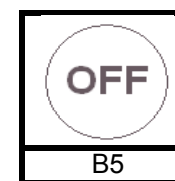

B5

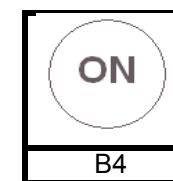

B4

12MM Anti-Vandal-Switch

Part No.: **Q36049-**

| | | | | | | | | | | |
|-------|--------|------|--------|--------|--------|-----------|-----------|------|------------|-----------|
| DRW: | Jason | CHKD | Wilson | MATL: | Wilson | TOLERANCE | Mason | DATE | 18.06.2017 | Customer: |
| APPD: | Schumi | | | FINISH | Jamy | | Sheet No. | | 2 from 3 | |

EDCON-COMPONENTS



Ordering Information

| Serie | Front Shape | Contact Structure | Lamp Type | Connect Type | Knob Color | Lamp Voltage | Crust Material | Engraving Options | ROHS | Packing Style |
|----------------|-------------|-------------------|-----------|--------------|------------|--------------|----------------|-------------------|----------|---------------|
| Q36049- | B | 10 | N | 1 | A | 0 | N | XX | R | N |

| | | | | | | | | | |
|-----------------|----------------|-----------------------|-----------------------------------|------------------------|-------------------|-------------------------------|--|----------------------------|------------------------------|
| | 10= 1NO | N= no Function | 1= Solder Lug 2,0x0,4mm | A= Same us Body | 0= without | S= Stainless Steel | XX= w/o other Look Order Code Engraving Options | R= ROHS Conform | N= White Carton |
| B= Domed | | | | | | N= Nickel Plated Brass | | N= NON ROHS Conform | I= Individual Packing |
| | | | | | | G= Gold Plated Brass | | | |
| | | | | | | | | | |
| | | | | | | | | | |
| | | | | | | | | | |
| | | | | | | | | | |
| | | | | | | | | | |

| | |
|--------------------------------|----------------|
| 12MM Anti-Vandal-Switch | |
| Part No.: | Q36049- |
| Customer: | |

| | | | | | | | | | |
|-------|--------|------|--------|--------|--------|-----------|-----------|------|------------|
| DRW: | Jason | CHKD | Wilson | MATL: | Wilson | TOLERANCE | Mason | DATE | 18.06.2017 |
| APPD: | Schumi | | | FINISH | Jamy | | Sheet No. | | 3 from 3 |