



DATA SHEET

DC-FAN Size 120x120x38mm

Serie: K11038

DC-FAN Size 120x120x38mm
Serie No.: K11038
Customer:

DRW:	Jason	CHKD	Wilson	MATL:	Wilson	TOLERANCE	Mason	DATE	16.12.2011
APPD:	Schumi			FINISH	Jamy		Sheet No.		1 from 5

EDCON-COMPONENTS



Specifications

Frame: Thermal Plastic UL 94V-0
 Impeller: Thermal Plastic UL 94V-0
 Lead Wire Type: UL Type
 Color of Lead Wire:
 Red (+)
 Black (-)

Operating Temperature: -10°C ~ +70°C
 Relative Humidity: 35% ~ 85% RH
 Storage Temperature: -40°C ~ +80°C
 Relative Humidity: 35% ~ 85% RH

Motor Protection: Impedance Protected
 Reverse Polarity Protected

Model Type	Bearing Systems	Available Features											Weight (gr)	
		Rated Voltage VDC	Operating Voltage VDC	Rated Current A	Rated Speed RPM	Air Flow CFM	Air Pressure mmH2O	Noise Level dBA	Tachometer Output	Rotation Detector	Thermal Control	Pulse Width Modulation		
10	Ball	48	24,0~55,2	1,30	6000	283,0	46,9	70	X	X		X		350

DC-FAN Size	
120x120x38mm	
Part No.:	K11038
Customer:	

DRW:	Jason	CHKD	Wilson	MATL:	Wilson	TOLERANCE	Mason	DATE	16.12.2011
APPD:	Schumi			FINISH	Jamy		Sheet No.	2 from 5	

EDCON-COMPONENTS

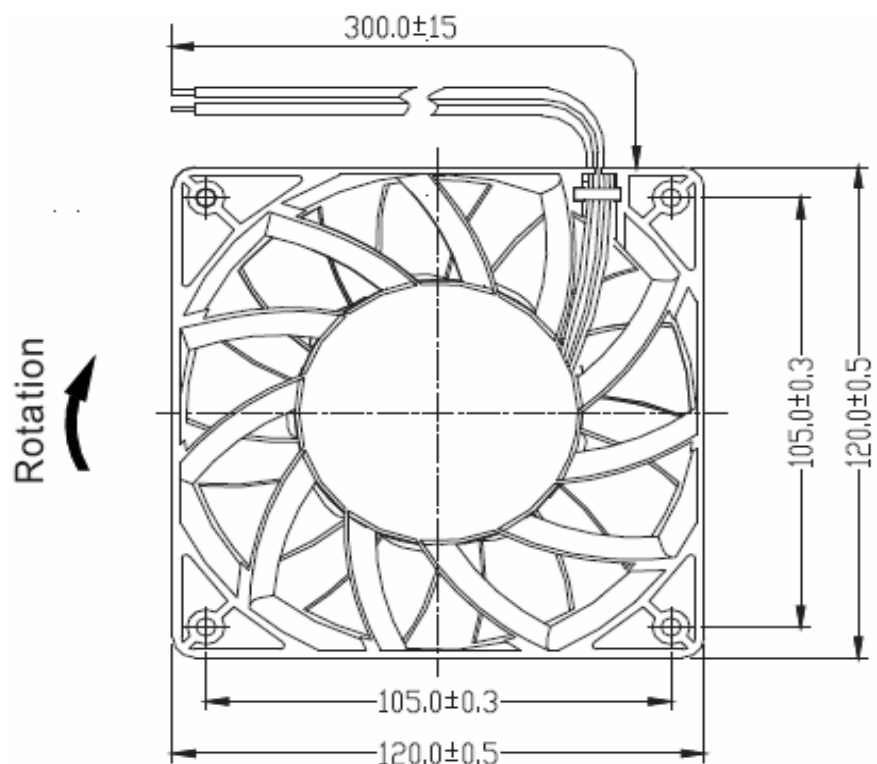
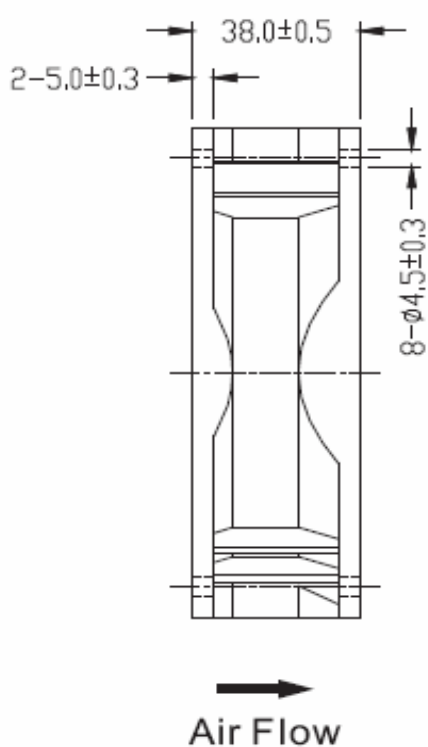

Unit: mm

DC-FAN Size	
120x120x38mm	
Part No.:	K11038
Customer:	

DRW:	Jason	CHKD	Wilson	MATL:	Wilson	TOLERANCE	Mason	DATE	16.12.2011
APPD:	Schumi			FINISH	Jamy		Sheet No.	3 from 5	

www.edcon-components.com

email: info@edcon-components.com



Performance Curves

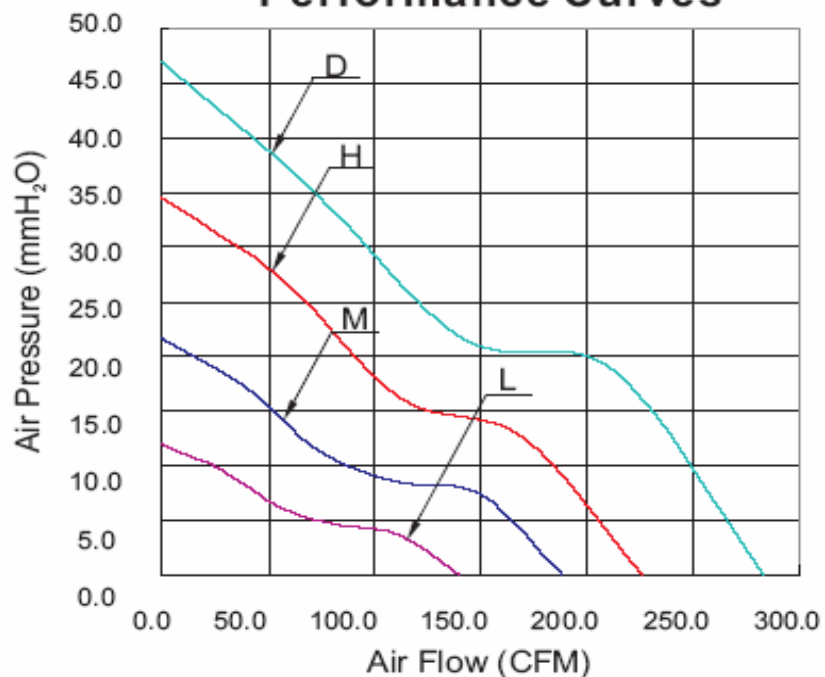

Type H = Model 07
 Type M = Model 08
 Type L = Model 09
 Type D = Model 10

DC-FAN Size 120x120x38mm	
Part No.:	K11038
Customer:	

DRW:	Jason	CHKD	Wilson	MATL:	Wilson	TOLERANCE	Mason	DATE	16.12.2011
APPD:	Schumi			FINISH	Jamy		Sheet No.	4 from 5	

EDCON-COMPONENTS



Ordering Informations

Serie + Model.No.	Model Type	Voltage	Bearing Type	Voltage Type	Impeller	Optional Features	Cable Options	Future Features	ROHS	Packing Code
K11038	10	048	B	2	A	0	A300	X	R	CA

048= 48Volt			A= Standard Impeller	0= No features	A300= Standard Wire length 300mm	X= No Features	R= ROHS Conform	CA= Carton Package
	B= Ball Type	2= DC Type	X= Special Impeller	1= Tachometer Output	Axxx= Wire length xxxmm			
				2= Rotation Detector				
				4= Pulse Width Modulation				

DC-FAN Size 120x120x38mm
Part No.: K11038
Customer:

DRW:	Jason	CHKD	Wilson	MATL:	Wilson	TOLERANCE	Mason	DATE	16.12.2011
APPD:	Schumi			FINISH	Jamy		Sheet No.		5 from 5