



# DATA SHEET

## DC-FAN Size 120x120x38mm

### Serie: K11038

<b>DC-FAN Size 120x120x38mm</b>
Serie No.: <b>K11038</b>
Customer:

DRW:	Jason	CHKD	Wilson	MATL:	Wilson	TOLERANCE	Mason	DATE	16.12.2011
APPD:	Schumi			FINISH	Jamy		Sheet No.		1 from 5

# EDCON-COMPONENTS



## Specifications

Frame: Thermal Plastic UL 94V-0  
 Impeller: Thermal Plastic UL 94V-0  
 Lead Wire Type: UL Type  
 Color of Lead Wire:  
 Red (+)  
 Black (-)

Operating Temperature: -10°C ~ +70°C  
 Relative Humidity: 35% ~ 85% RH  
 Storage Temperature: -40°C ~ +80°C  
 Relative Humidity: 35% ~ 85% RH

Motor Protection: Impedance Protected  
 Reverse Polarity Protected

Model Type	Bearing Systems	Available Features											Weight (gr)	
		Rated Voltage VDC	Operating Voltage VDC	Rated Current A	Rated Speed RPM	Air Flow CFM	Air Pressure mmH2O	Noise Level dBA	Tachometer Output	Rotation Detector	Thermal Control	Pulse Width Modulation		
07	Sleeve	12	6,0~13,8	3,60	5000	226,0	34,4	65	X	X		X		350

<b>DC-FAN Size</b>	
<b>120x120x38mm</b>	
Part No.:	<b>K11038</b>
Customer:	

DRW:	Jason	CHKD	Wilson	MATL:	Wilson	TOLERANCE	Mason	DATE	16.12.2011
APPD:	Schumi			FINISH	Jamy		Sheet No.	2 from 5	

# EDCON-COMPONENTS

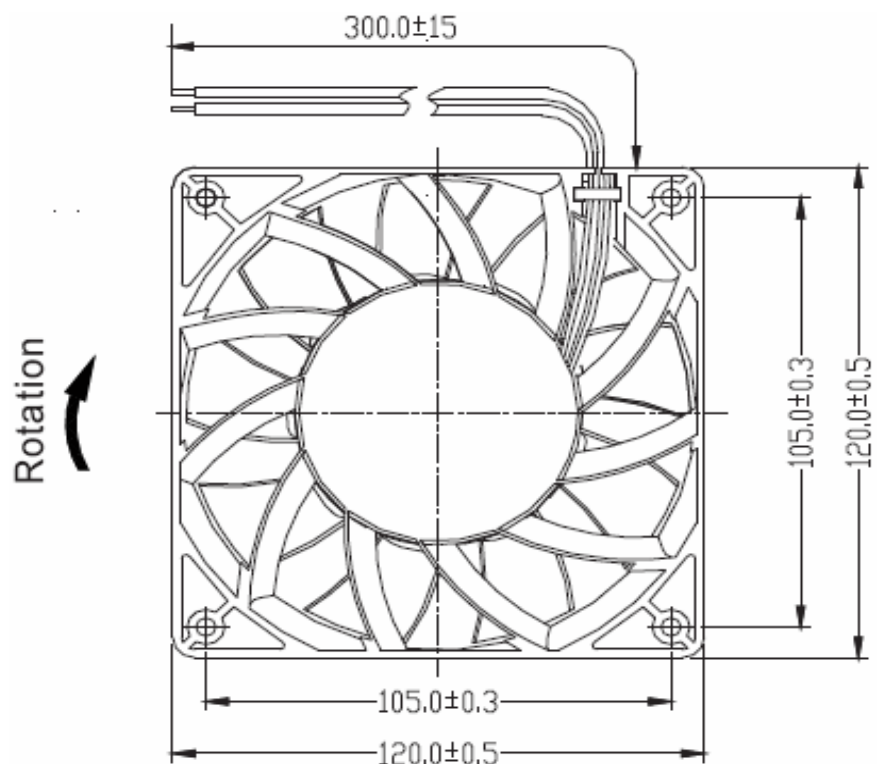
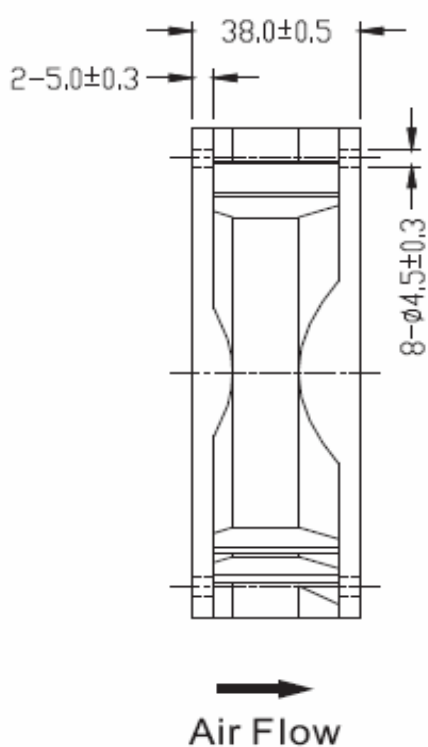

Unit: mm

<b>DC-FAN Size</b>	
<b>120x120x38mm</b>	
Part No.:	<b>K11038</b>
Customer:	

DRW:	Jason	CHKD	Wilson	MATL:	Wilson	TOLERANCE	Mason	DATE	16.12.2011
APPD:	Schumi			FINISH	Jamy		Sheet No.	3 from 5	

[www.edcon-components.com](http://www.edcon-components.com)

email: [info@edcon-components.com](mailto:info@edcon-components.com)



**Performance Curves**

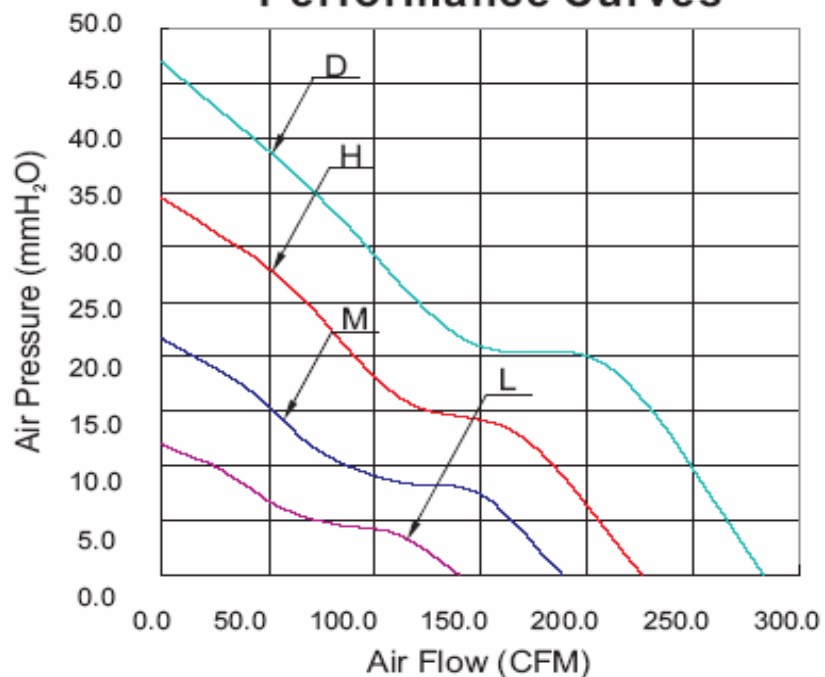

Type H = Model 07  
 Type M = Model 08  
 Type L = Model 09  
 Type D = Model 10

<b>DC-FAN Size</b> <b>120x120x38mm</b>	
Part No.:	<b>K11038</b>
Customer:	

DRW:	Jason	CHKD	Wilson	MATL:	Wilson	TOLERANCE	Mason	DATE	16.12.2011
APPD:	Schumi			FINISH	Jamy		Sheet No.	4 from 5	

# EDCON-COMPONENTS



## Ordering Informations

Serie + Model.No.	Model Type	Voltage	Bearing Type	Voltage Type	Impeller	Optional Features	Cable Options	Future Features	ROHS	Packing Code
<b>K11038</b>	<b>07</b>	<b>012</b>	<b>S</b>	<b>2</b>	<b>A</b>	<b>0</b>	<b>A300</b>	<b>X</b>	<b>R</b>	<b>CA</b>

<b>012=</b> 12Volt	<b>S=</b> Sleeve Type		<b>A=</b> Standard Impeller	<b>0=</b> No features	<b>A300=</b> Standard Wire length 300mm	<b>X=</b> No Features	<b>R=</b> ROHS Conform	<b>CA=</b> Carton Package
		<b>2=</b> DC Type	<b>X=</b> Special Impeller	<b>1=</b> Tachometer Output				
				<b>2=</b> Rotation Detector	<b>Axxx=</b> Wire length xxxmm		<b>N=</b> NON ROHS Conform	<b>IV=</b> Individual Package
				<b>4=</b> Pulse Width Modulation				

<b>DC-FAN Size</b> <b>120x120x38mm</b>
Part No.: <b>K11038</b>
Customer:

DRW:	Jason	CHKD	Wilson	MATL:	Wilson	TOLERANCE	Mason	DATE	16.12.2011
APPD:	Schumi			FINISH	Jamy		Sheet No.		5 from 5