



DATA SHEET

DC-FAN Size 120x120x38mm

Serie: K11038

DC-FAN Size 120x120x38mm
Serie No.: K11038
Customer:

DRW:	Jason	CHKD	Wilson	MATL:	Wilson	TOLERANCE	Mason	DATE	16.12.2011
APPD:	Schumi			FINISH	Jamy		Sheet No.		1 from 5

EDCON-COMPONENTS



Specifications

Frame: Thermal Plastic UL 94V-0
 Impeller: Thermal Plastic UL 94V-0
 Lead Wire Type: UL Type
 Color of Lead Wire:
 Red (+)
 Black (-)

Operating Temperature: $-10^{\circ}\text{C} \sim +70^{\circ}\text{C}$
 Relative Humidity: 35% ~ 85% RH
 Storage Temperature: $-40^{\circ}\text{C} \sim +80^{\circ}\text{C}$
 Relative Humidity: 35% ~ 85% RH

Motor Protection: Impedance Protected
 Reverse Polarity Protected

Model Type	Bearing Systems	Available Features											Weight (gr)	
		Rated Voltage VDC	Operating Voltage VDC	Rated Current A	Rated Speed RPM	Air Flow CFM	Air Pressure mmH2O	Noise Level dBA	Tachometer Output	Rotation Detector	Thermal Control	Pulse Width Modulation		
05	Ball	24	12,0~27,6	0,40	2900	128,7	7,8	44	X	X		X		290

DC-FAN Size	
120x120x38mm	
Part No.:	K11038
Customer:	

DRW:	Jason	CHKD	Wilson	MATL:	Wilson	TOLERANCE	Mason	DATE	16.12.2011
APPD:	Schumi			FINISH	Jamy		Sheet No.	2 from 5	

EDCON-COMPONENTS

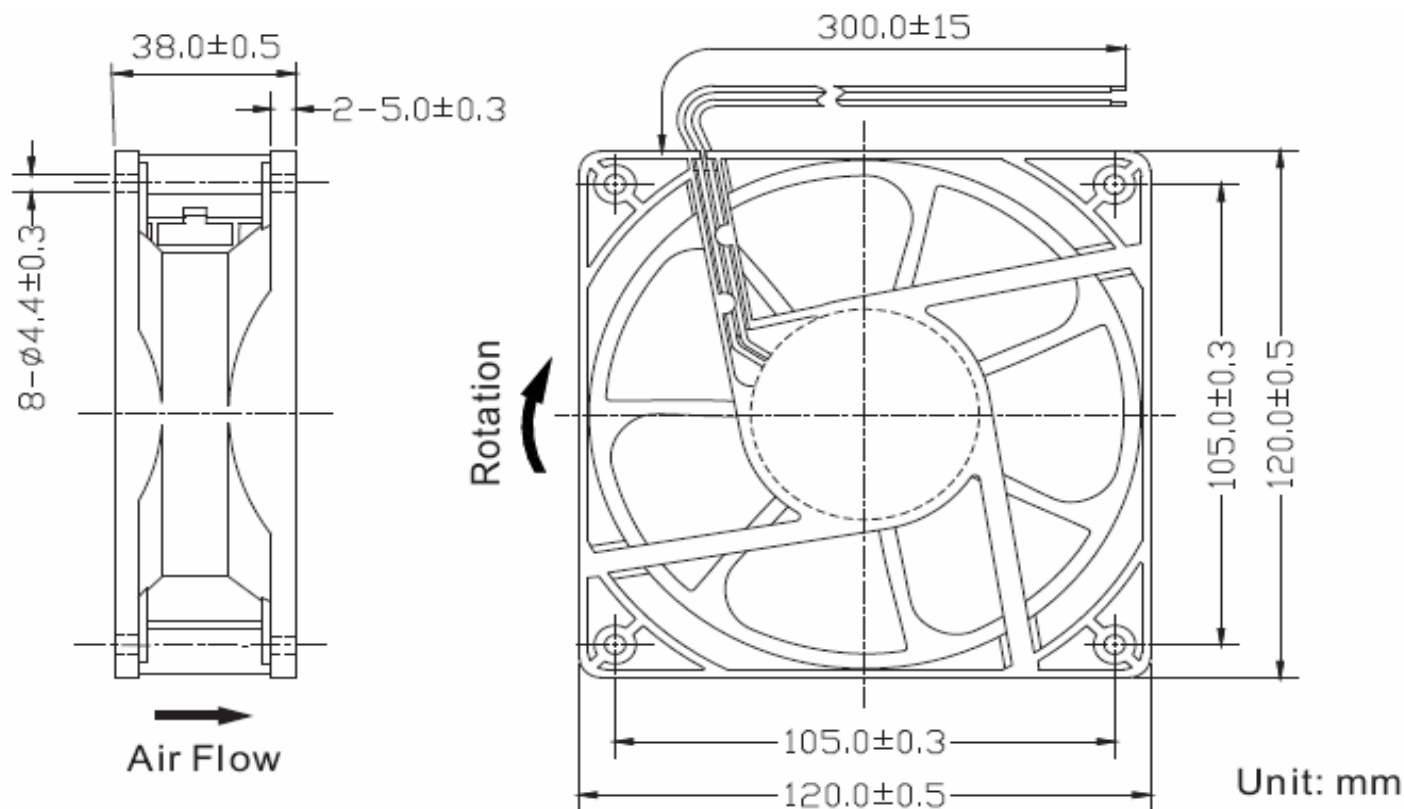

DC-FAN Size	
120x120x38mm	
Part No.:	K11038
Customer:	

DRW:	Jason	CHKD	Wilson	MATL:	Wilson	TOLERANCE	Mason	DATE	16.12.2011
APPD:	Schumi			FINISH	Jamy		Sheet No.	3 from 5	

www.edcon-components.com

email: info@edcon-components.com



Performance Curves

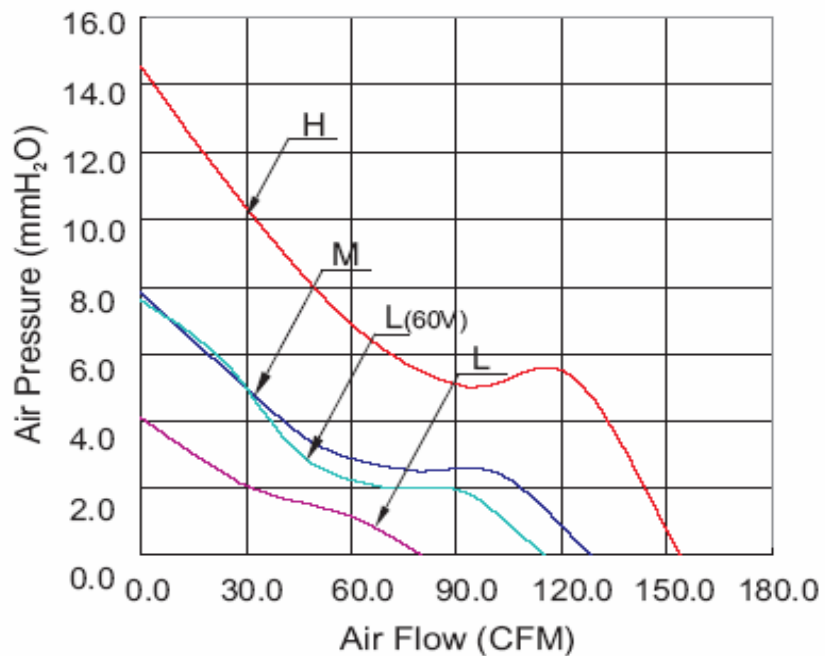

Type H = Model 04
 Type M = Model 05
 Type L = Model 06

DC-FAN Size	
120x120x38mm	
Part No.:	K11038
Customer:	

DRW:	Jason	CHKD	Wilson	MATL:	Wilson	TOLERANCE	Mason	DATE	16.12.2011
APPD:	Schumi			FINISH	Jamy		Sheet No.	4 from 5	

EDCON-COMPONENTS



Ordering Informations

Serie + Model.No.	Model Type	Voltage	Bearing Type	Voltage Type	Impeller	Optional Features	Cable Options	Future Features	ROHS	Packing Code
K11038	05	024	B	2	A	0	A300	X	R	CA

024= 24Volt			A= Standard Impeller	0= No features	A300= Standard Wire length 300mm	X= No Features	R= ROHS Conform	CA= Carton Package
	B= Ball Type	2= DC Type	X= Special Impeller	1= Tachometer Output	Axxx= Wire length xxxmm			
				2= Rotation Detector				
				4= Pulse Width Modulation				

DC-FAN Size 120x120x38mm
Part No.: K11038
Customer:

DRW:	Jason	CHKD	Wilson	MATL:	Wilson	TOLERANCE	Mason	DATE	16.12.2011
APPD:	Schumi			FINISH	Jamy		Sheet No.		5 from 5