



DATA SHEET

DC-FAN Size 80x80x25mm

Serie: K11031

DC-FAN Size 80x80x25mm
Serie No.: K11031
Customer:

DRW:	Jason	CHKD	Wilson	MATL:	Wilson	TOLERANCE	Mason	DATE	14.12.2011
APPD:	Schumi			FINISH	Jamy		Sheet No.		1 from 5

EDCON-COMPONENTS



Specifications

Frame: Thermal Plastic UL 94V-0
 Impeller: Thermal Plastic UL 94V-0
 Lead Wire Type: UL Type
 Color of Lead Wire:
 Red (+)
 Black (-)

Operating Temperature: -10°C ~ +70°C
 Relative Humidity: 35% ~ 85% RH
 Storage Temperature: -40°C ~ +80°C
 Relative Humidity: 35% ~ 85% RH

Motor Protection: Impedance Protected
 Reverse Polarity Protected

Model Type	Bearing Systems	Available Features											Weight (gr)	
		Rated Voltage VDC	Operating Voltage VDC	Rated Current A	Rated Speed RPM	Air Flow CFM	Air Pressure mmH2O	Noise Level dBA	Tachometer Output	Rotation Detector	Thermal Control	Pulse Width Modulation		
08	Ball	24	12,0~27,6	0,12	2500	24,3	2,6	28	X	X				76

DC-FAN Size 80x80x25mm	
Part No.:	K11031
Customer:	

DRW:	Jason	CHKD	Wilson	MATL:	Wilson	TOLERANCE	Mason	DATE	14.12.2011
APPD:	Schumi			FINISH	Jamy		Sheet No.	2 from 5	

EDCON-COMPONENTS

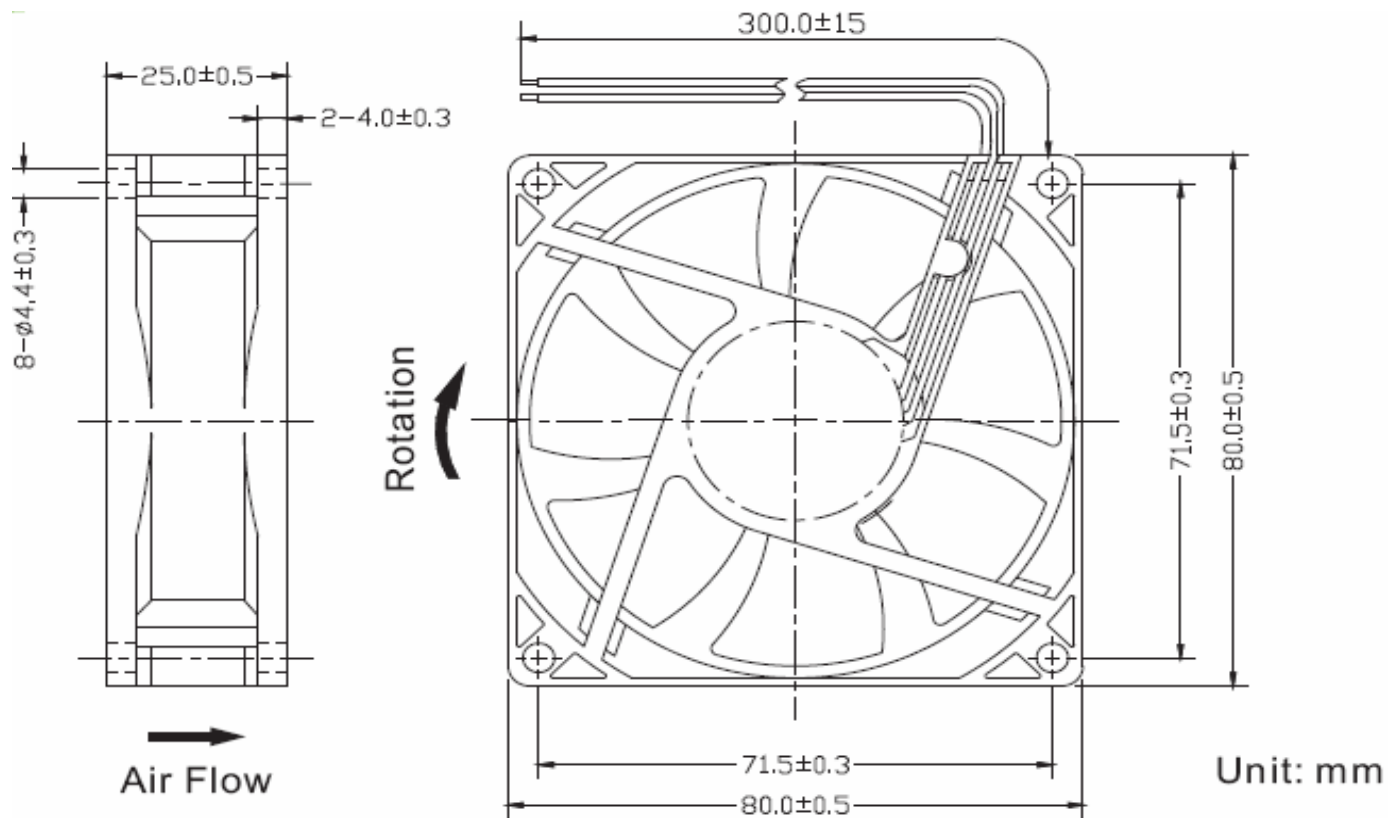

DC-FAN Size 80x80x25mm	
Part No.:	K11031
Customer:	

DRW:	Jason	CHKD	Wilson	MATL:	Wilson	TOLERANCE	Mason	DATE	14.12.2011
APPD:	Schumi			FINISH	Jamy		Sheet No.	3 from 5	

www.edcon-components.com

email: info@edcon-components.com



Performance Curves

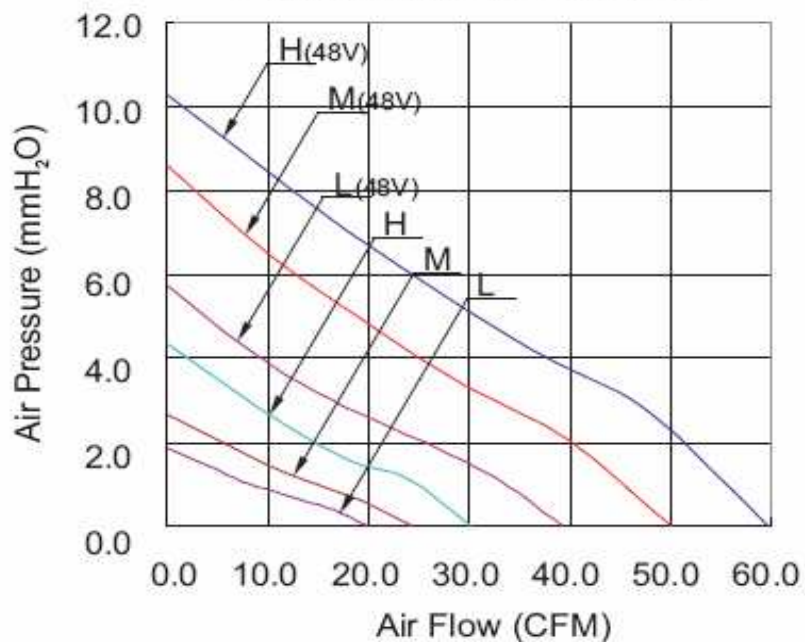

Type H = Model 07
 Type M = Model 08
 Type L = Model 09

DC-FAN Size 80x80x25mm	
Part No.:	K11031
Customer:	

DRW:	Jason	CHKD	Wilson	MATL:	Wilson	TOLERANCE	Mason	DATE	14.12.2011
APPD:	Schumi			FINISH	Jamy		Sheet No.	4 from 5	

EDCON-COMPONENTS



Ordering Informations

Serie + Model.No.	Model Type	Voltage	Bearing Type	Voltage Type	Impeller	Optional Features	Cable Options	Future Features	ROHS	Packing Code
K11031	08	024	B	2	A	0	A300	X	R	CA

024= 24Volt			A= Standard Impeller	0= No features	A300= Standard Wire length 300mm	X= No Features	R= ROHS Conform	CA= Carton Package
	B= Ball Type	2= DC Type	X= Special Impeller	1= Tachometer Output	Axxx= Wire length xxxmm			
				2= Rotation Detector				

DC-FAN Size 80x80x25mm
Part No.: K11031
Customer:

DRW:	Jason	CHKD	Wilson	MATL:	Wilson	TOLERANCE	Mason	DATE	14.12.2011
APPD:	Schumi			FINISH	Jamy		Sheet No.		5 from 5