

# EDCON-COMPONENTS



## Technical Discription

Designed for flat helix winding coil high curent high volt \*time applications  
 Lowest DCR, lower loss reduce size, high efficiency, less Temperature  
 Winding to core isolation is 500 Vrms  
 Inductance tested at 500KHz, 0,1Vrms  
 DC current at which the inductance drops. The specified amount from ist without current.  
 Winding: temperature rise = 130°C max.  
 Operating temperature range -25°C ~ +100°C  
 Electrical specifications at 25°C  
 Inductance tolerance ±20%

## Range Informations

Inductance (µH) typ	34,0
. @ 0 ADC	38,0
. @ I sat	34,2

DCR (mΩ) max.	5,5
I sat (A DC)	13,0

## Drawing

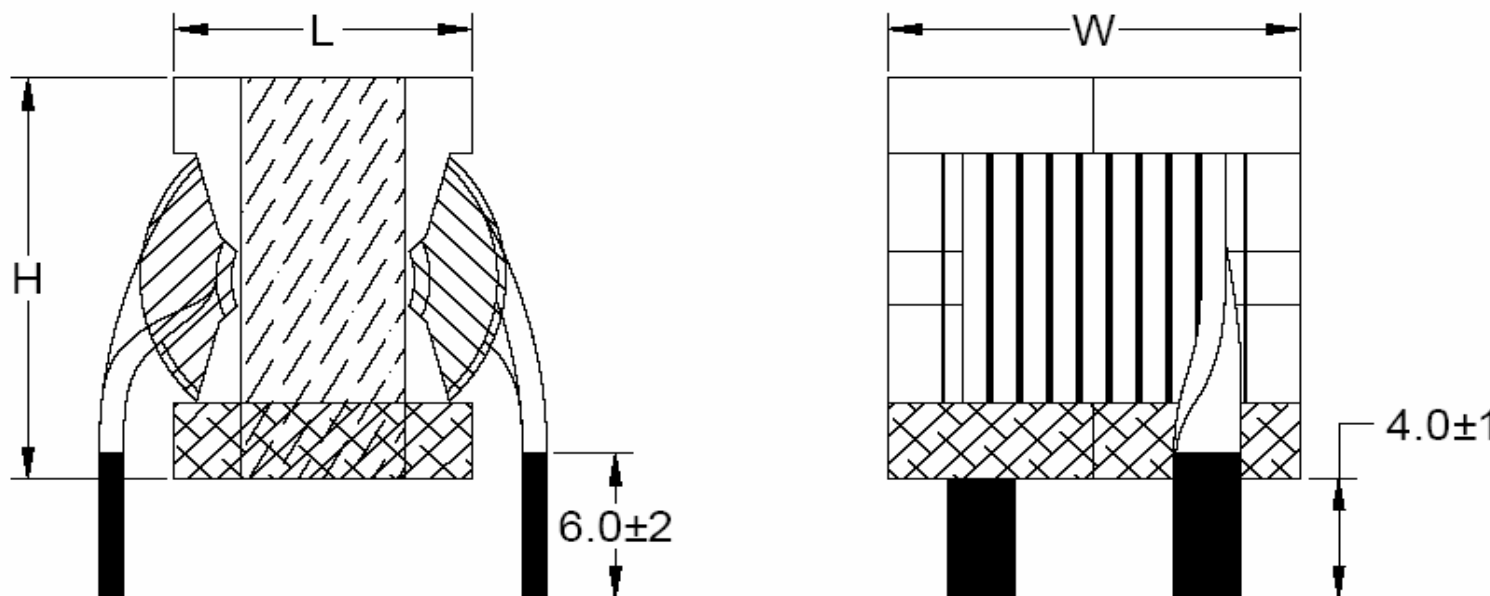

Dimension (mm)	
L	32,0
W	21,7
H	34,0

PCB Hole Dimension	
1,4x6,5 mm	

<b>FLAT WINDING HIGH POWER COIL</b>	
Part No.:	<b>S10R60</b>

DRW:	Jason	CHKD	Wilson	MATL:	Wilson	TOLERANCE	Mason	DATE	12.09.2011
APPD:	Schumi			FINISH	Jamy		Sheet No.	1 from 3	Customer:

# EDCON-COMPONENTS



## Ordering Informations

Serie	Range Code	Tolerance Code	ROHS	Packing						
-------	------------	----------------	------	---------	--	--	--	--	--	--

<b>S10R60</b>	<b>340</b>	<b>M</b>	<b>R</b>	<b>TU</b>						
---------------	------------	----------	----------	-----------	--	--	--	--	--	--

<b>340= 34μH</b>	<b>M= ±20%</b>	<b>R= ROHS Conform</b>	<b>TU= Tube Packing</b>
			<b>TY= Tray Packing</b>

<b>FLAT WINDING HIGH POWER COIL</b>
Part No.: <b>S10R60</b>
Customer:

DRW:	Jason	CHKD	Wilson	MATL:	Wilson	TOLERANCE	Mason	DATE	12.09.2011
APPD:	Schumi			FINISH	Jamy		Sheet No.	2 from 3	



**Soldering Profile Curve**

**Classification Reflow Profile (JEDEC J-STD-020C)**

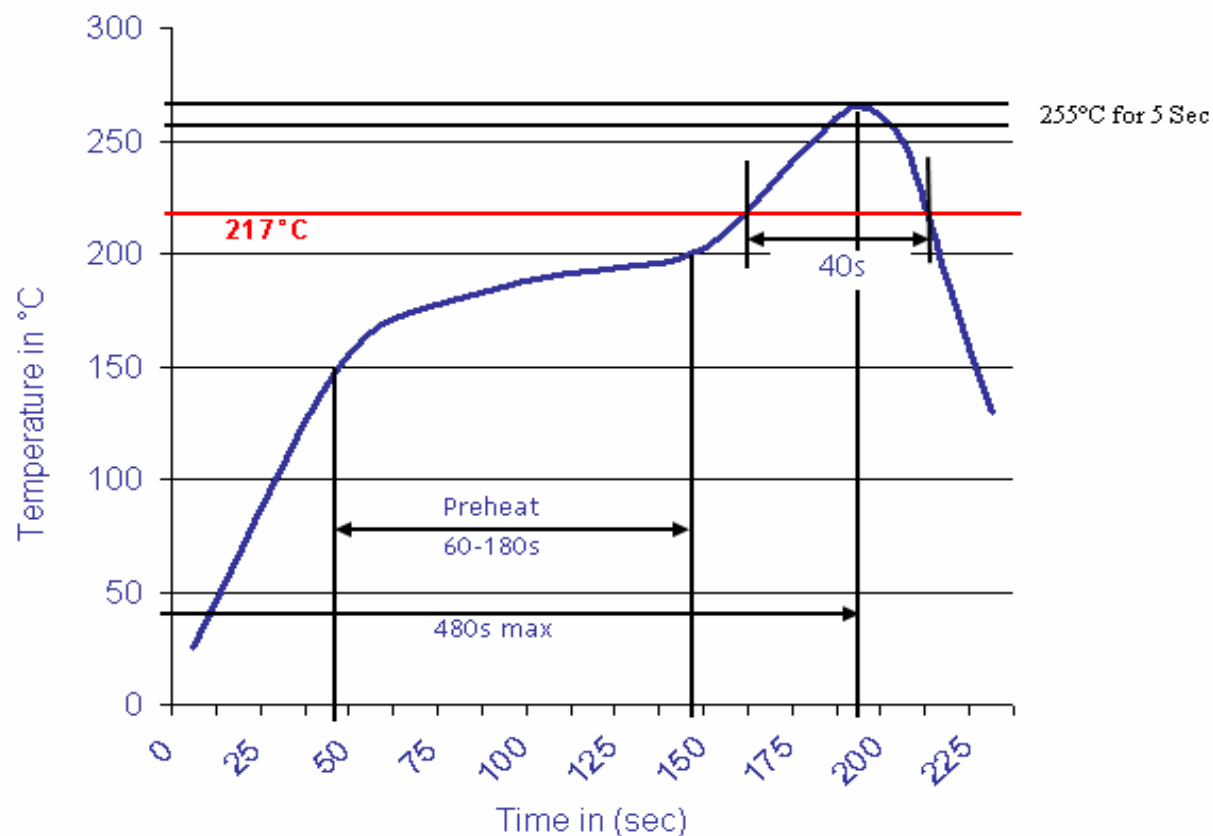

<b>FLAT WINDING HIGH POWER COIL</b>	
Part No.:	<b>S10R60</b>
Customer:	

DRW:	Jason	CHKD	Wilson	MATL:	Wilson	TOLERANCE	Mason	DATE	12.09.2011
APPD:	Schumi			FINISH	Jamy		Sheet No.		3 from 3

[www.edcon-components.com](http://www.edcon-components.com)

email: [info@edcon-components.com](mailto:info@edcon-components.com)