



# DATA SHEET

## DIN 41612 Connector Type-C

**Serie: T22032**

**Type Male**

**Full-Size**

**Wire Wrap Press-Fit**

**Straight Pin**

**DIN 41612 Connector Type-C**

Serie No.: **T22032**

Customer:

DRW:	Jason	CHKD	Wilson	MATL:	Wilson	TOLERANCE	Mason	DATE	09.05.2014
APPD:	Schumi			FINISH	Jamy		Sheet No.		1 from 5

# EDCON-COMPONENTS

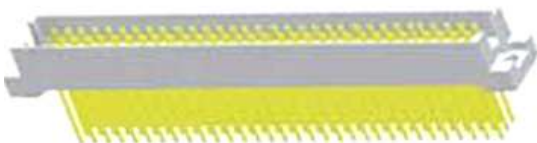

## Specifications

column w. contacts	column w. contacts	column w. contacts	column w. contacts	column w. contacts	column w. contacts	column w. contacts	column w. contacts
1, 2, 3.....	1, 3, 5.....	2, 4, 6.....	1, 2, 3.....	1, 3, 5.....	2, 4, 6.....	2, 4, 6.....	1, 3, 5.....
Row with contacts	Row with contacts	Row with contacts	Row with contacts	Row with contacts	Row with contacts	Row with contacts	Row with contacts
abc	abc	abc	ac	ac	ac	a	a
Connecting Order Code	Connecting Order Code	Connecting Order Code	Connecting Order Code	Connecting Order Code	Connecting Order Code	Connecting Order Code	Connecting Order Code
<b>A1</b>	<b>A2</b>	<b>A3</b>	<b>A4</b>	<b>A5</b>	<b>A6</b>	<b>A7</b>	<b>A8</b>

column w. contacts
1, 3, 5.....
Row with contacts
a
Connecting Order Code
<b>A9</b>

### Technical Description

Contact Resistance:	20m Ω Max:
Insulation Resistance:	1000M Ω Min:
Curent Rating:	2A
Dielectric Withstanding Voltage:	AC 1000V (r.m.s.) / 60s
Operating Temperature:	.- 55°C to + 125°C
Material Housing:	PBT
Material Contact:	copper Alloy
Contact plating	tin and gold look order code

**DIN 41612 Connector Type-  
C**

Part No.: **T22032**

DRW:	Jason	CHKD	Wilson	MATL:	Wilson	TOLERANCE	Mason	DATE	09.05.2014	Customer:
APPD:	Schumi			FINISH	Jamy		Sheet No.	2 from 5		

# EDCON-COMPONENTS

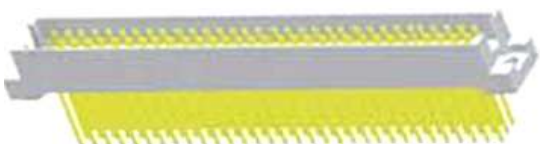

## Drawing

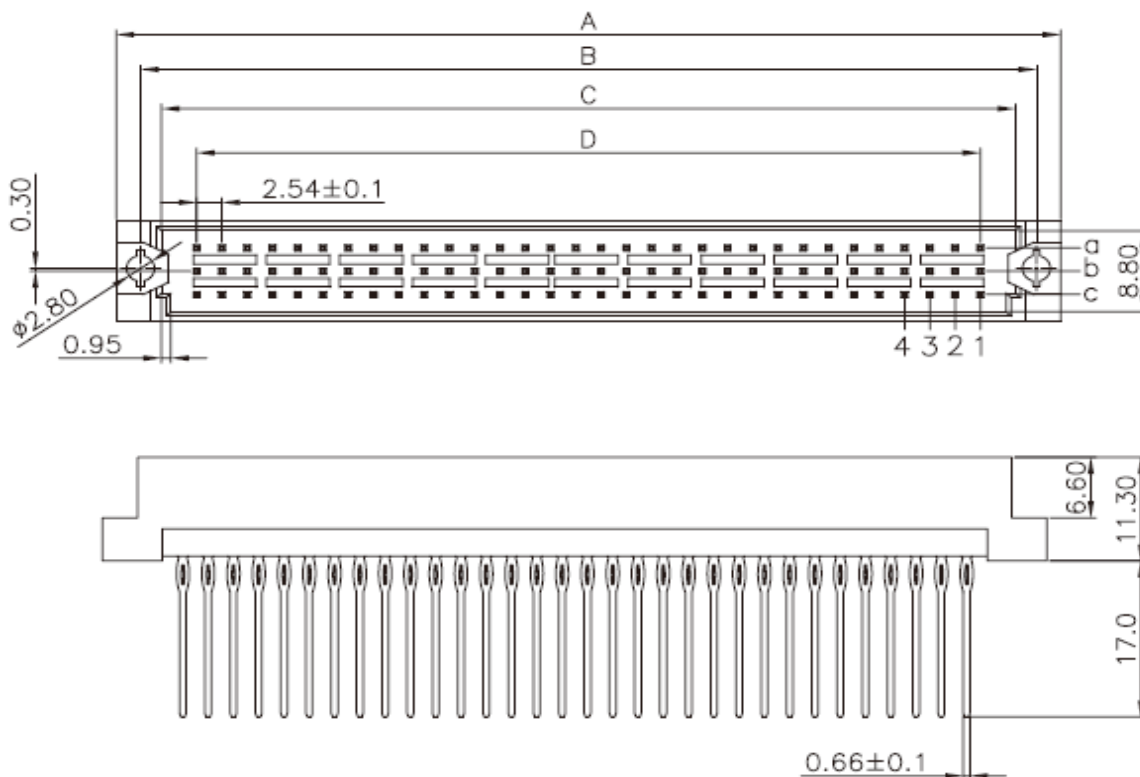

## PCB Layout

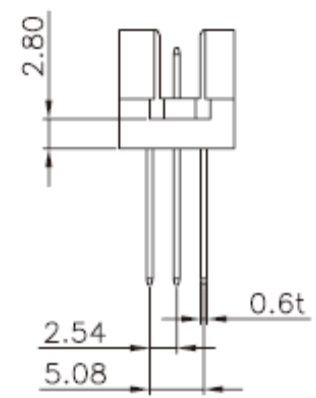
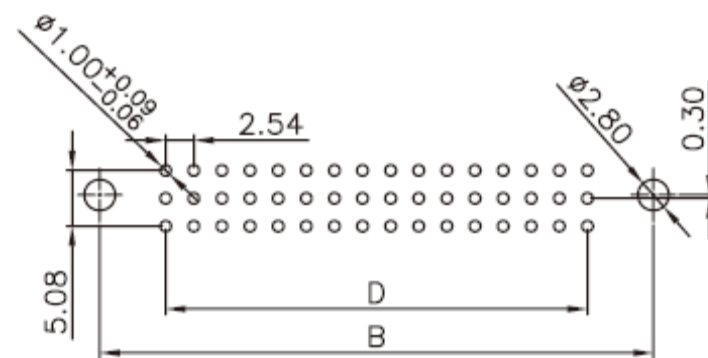

Positions	A	B	C	D
96P (3x32)	94,90	90,00	85,80	78,74

<b>DIN 41612 Connector Type-C</b>	
Part No.:	<b>T22032</b>
Customer:	

DRW:	Jason	CHKD	Wilson	MATL:	Wilson	TOLERANCE	Mason	DATE	09.05.2014
APPD:	Schumi			FINISH	Jamy		Sheet No.	3 from 5	

[www.edcon-components.com](http://www.edcon-components.com)

email: [info@edcon-components.com](mailto:info@edcon-components.com)

# EDCON-COMPONENTS



## Ordering Informations

Serie	Number of Position	Contact Plating	Connecting Order Code	ROHS	Packing Code					
-------	--------------------	-----------------	-----------------------	------	--------------	--	--	--	--	--

<b>T22032</b>	<b>96</b>	<b>G0</b>	<b>A1</b>	<b>R</b>	<b>BU</b>					
---------------	-----------	-----------	-----------	----------	-----------	--	--	--	--	--

<b>96=</b> 96Pos.	<b>TN=</b> Tin plated	<b>Ax=</b> look table	<b>R=</b> ROHS Conform	<b>BU=</b> Bulk Ware
<b>64=</b> 64Pos.	<b>G0=</b> selectiv Gold flash		<b>N=</b> NON ROHS Conform	<b>TY=</b> Tray Packing
<b>32=</b> 32Pos.	<b>GA=</b> selectiv 3µ Gold			
<b>16=</b> 16Pos.	<b>GB=</b> selectiv 10µ Gold			

**DIN 41612 Connector Type-C**

Part No.: **T22032**

Customer:

DRW:	Jason	CHKD	Wilson	MATL:	Wilson	TOLERANCE	Mason	DATE	09.05.2014
APPD:	Schumi			FINISH	Jamy		Sheet No.	4 from 5	

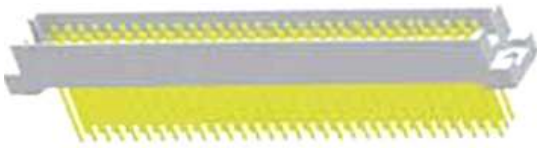

**Soldering Profile Curve**

**Classification Reflow Profile (JEDEC J-STD-020C)**

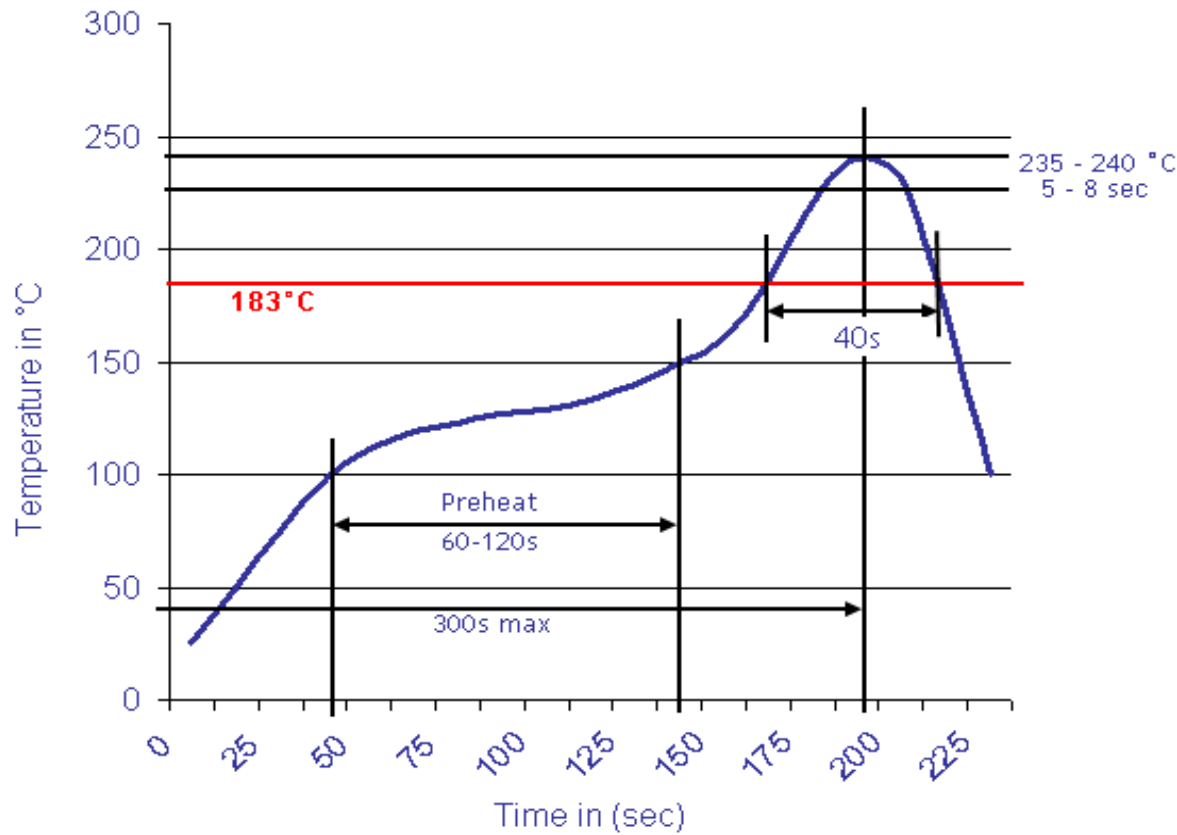

**DIN 41612 Connector Type-C**

Part No.: **T22032**

Customer:

DRW:	Jason	CHKD	Wilson	MATL:	Wilson	TOLERANCE	Mason	DATE	09.05.2014
APPD:	Schumi			FINISH	Jamy		Sheet No.	5 from 5	

