



DATA SHEET

DIN 41612 Connector Type-C

Serie: T22030

Type Male

Full-Size

Wire Wrap

Straight Pin

DIN 41612 Connector Type-C

Serie No.: **T22030**

Customer:

DRW:	Jason	CHKD	Wilson	MATL:	Wilson	TOLERANCE	Mason	DATE	09.05.2014
APPD:	Schumi			FINISH	Jamy		Sheet No.		1 from 5

EDCON-COMPONENTS

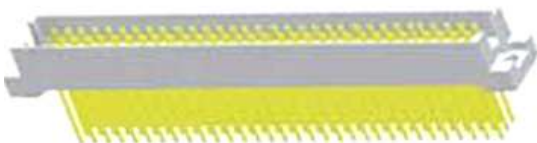

Specifications

column w. contacts	column w. contacts	column w. contacts	column w. contacts	column w. contacts	column w. contacts	column w. contacts	column w. contacts
1, 2, 3.....	1, 3, 5.....	2, 4, 6.....	1, 2, 3.....	1, 3, 5.....	2, 4, 6.....	2, 4, 6.....	1, 3, 5.....
Row with contacts	Row with contacts	Row with contacts	Row with contacts	Row with contacts	Row with contacts	Row with contacts	Row with contacts
abc	abc	abc	ac	ac	ac	a	a
Connecting Order Code	Connecting Order Code	Connecting Order Code	Connecting Order Code	Connecting Order Code	Connecting Order Code	Connecting Order Code	Connecting Order Code
A1	A2	A3	A4	A5	A6	A7	A8

column w. contacts
1, 3, 5.....
Row with contacts
a
Connecting Order Code
A9

Technical Description

Contact Resistance:	20m Ω Max:
Insulation Resistance:	1000M Ω Min:
Curent Rating:	2A
Dielectric Withstanding Voltage:	AC 1000V (r.m.s.) / 60s
Operating Temperature:	.- 55°C to + 125°C
Material Housing:	PBT
Material Contact:	copper Alloy
Contact plating	tin and gold look order code

**DIN 41612 Connector Type-
C**

Part No.: **T22030**

DRW:	Jason	CHKD	Wilson	MATL:	Wilson	TOLERANCE	Mason	DATE	09.05.2014	Customer:
APPD:	Schumi			FINISH	Jamy		Sheet No.	2 from 5		

EDCON-COMPONENTS

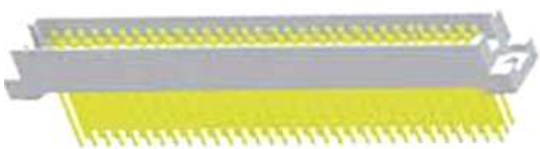

Drawing

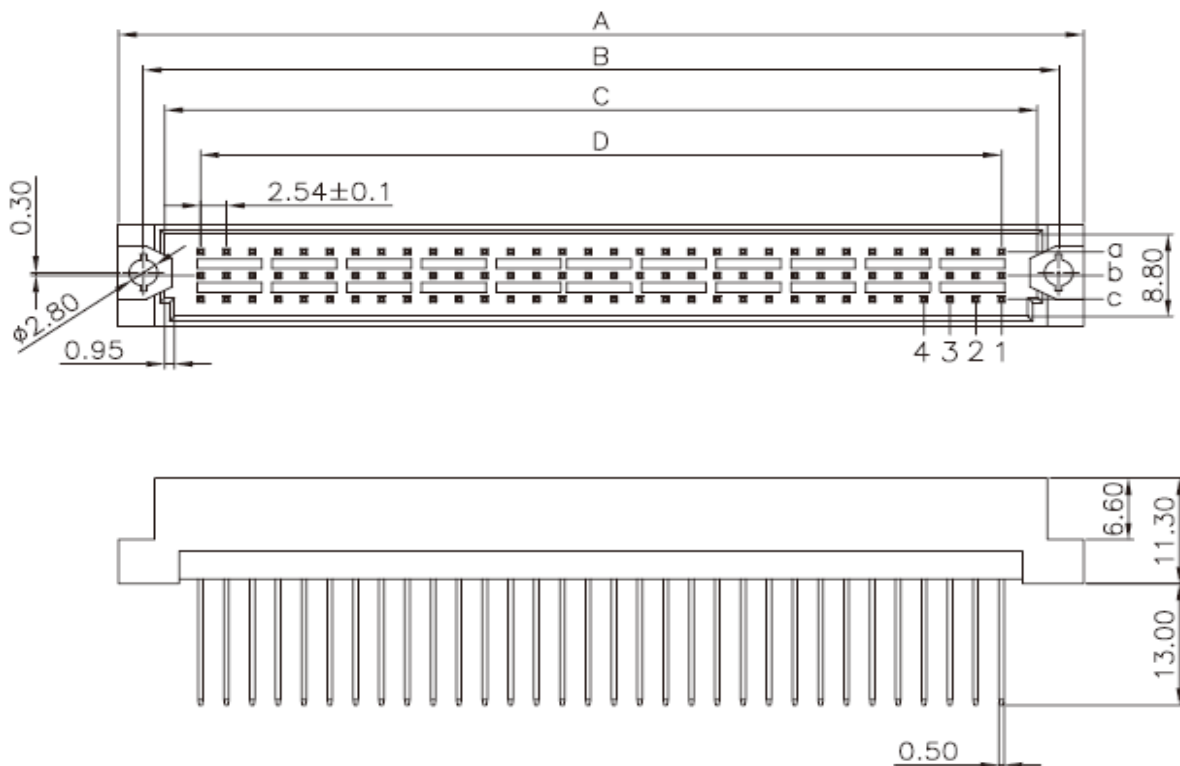

PCB Layout

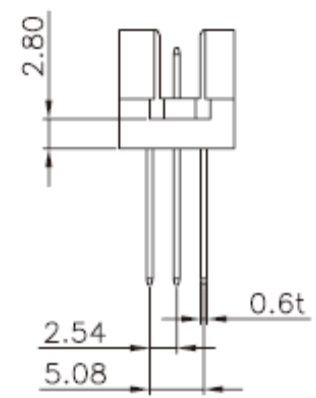
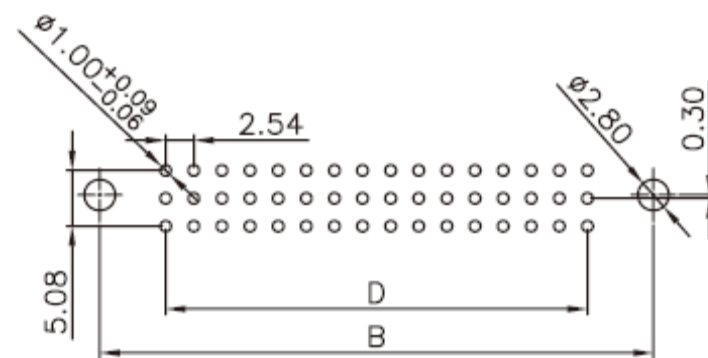

Positions	A	B	C	D
96P (3x32)	94,90	90,00	85,80	78,74

DIN 41612 Connector Type-C

Part No.: **T22030**

DRW:	Jason	CHKD	Wilson	MATL:	Wilson	TOLERANCE	Mason	DATE	09.05.2014
APPD:	Schumi			FINISH	Jamy		Sheet No.	3 from 5	Customer:

www.edcon-components.com

email: info@edcon-components.com

EDCON-COMPONENTS



Ordering Informations

Serie	Number of Position	Contact Plating	Connecting Order Code	ROHS	Packing Code					
-------	--------------------	-----------------	-----------------------	------	--------------	--	--	--	--	--

T22030	96	G0	A1	R	BU					
---------------	-----------	-----------	-----------	----------	-----------	--	--	--	--	--

96= 96Pos.	TN= Tin plated	Ax= look table	R= ROHS Conform	BU= Bulk Ware
64= 64Pos.	G0= selectiv Gold flash		N= NON ROHS Conform	TY= Tray Packing
32= 32Pos.	GA= selectiv 3μ Gold			
16= 16Pos.	GB= selectiv 10μ Gold			

DIN 41612 Connector Type-C

Part No.: **T22030**

Customer:

DRW:	Jason	CHKD	Wilson	MATL:	Wilson	TOLERANCE	Mason	DATE	09.05.2014
APPD:	Schumi			FINISH	Jamy		Sheet No.		4 from 5

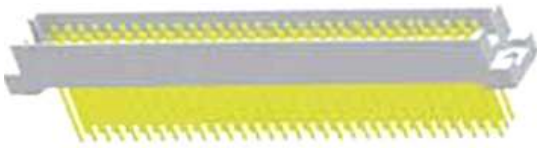

Soldering Profile Curve

Classification Reflow Profile (JEDEC J-STD-020C)

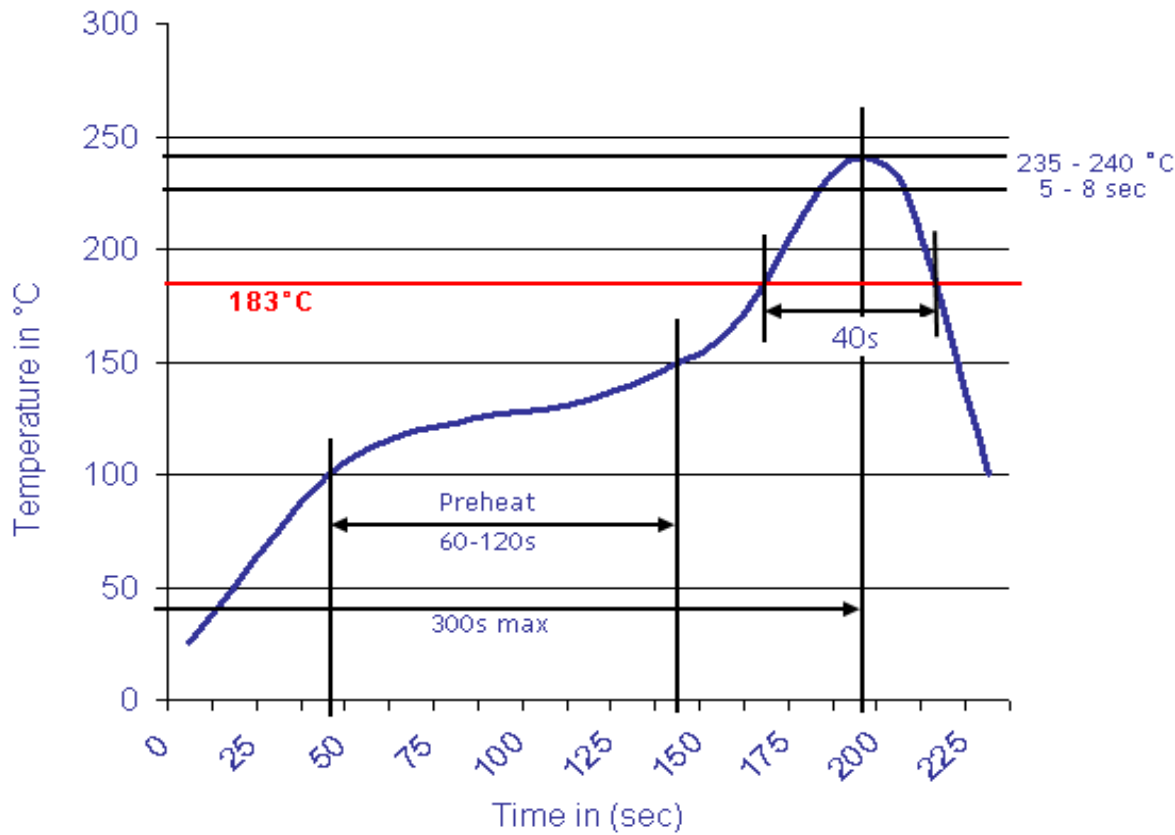

DIN 41612 Connector Type-C

Part No.: **T22030**

Customer:

DRW:	Jason	CHKD	Wilson	MATL:	Wilson	TOLERANCE	Mason	DATE	09.05.2014
APPD:	Schumi			FINISH	Jamy		Sheet No.	5 from 5	

