



**Technical Spezification**

miniature terminal blocks, 2 conductors with fixing flanges, it's a wago style modular terminal blocks with cage clamp connection, and equivalent with wago 260 series terminal blocks and can be compatible with wago's.

Conductors	2
Wire Range:	0,2~1,5mm"
Wire Range	24~16 AWG
Rated Voltage:	400V (IEC), 300V(UL)
Rated Current:	18A(IEC) 10A(UL)
Insulating Material:	Nylon PA66 (UL94,V-0 or V-2)
Spring Cage Materials:	Spring Steel
Stripping Length:	8~9mm / 0,33

**Dimension**

Thickness:	5,0mm
Width:	25,0mm
Height:	17,0mm
Color of Body:	Gray, Orange, Light Gray, Blue, Gren-Yellow

**Drawing**

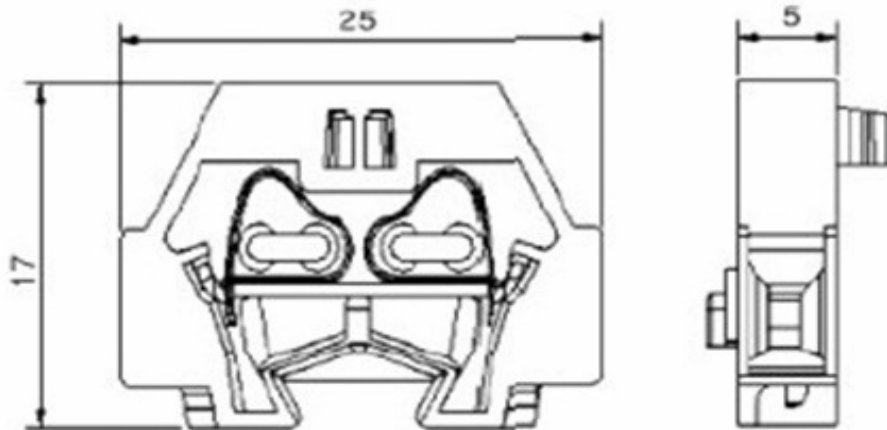

**Ordering Information**

Serie	Color of Body	ROHS	Packing			
<b>A29046</b>	<b>GY</b>	<b>R</b>	<b>BX</b>			

<b>GY=</b> Gray	<b>R=</b> ROHS Conform	<b>BU=</b> Bulk-Ware
<b>OR=</b> Orange		
<b>LG=</b> Light gray	<b>N=</b> NON ROHS Conform	<b>BX=</b> Box Packing
<b>BL=</b> Blue		
<b>GY=</b> Green Yellow		<b>IV=</b> Individuel Packing

<b>Mini Terminal Block</b>	
Part No.:	<b>A29046</b>
Customer:	

DRW:	Jason	CHKD	Wilson	MATL:	Wilson	DATE	18.08.2011
APPD:	Schumi			FINISH	Jamy	Sheet	1 from 1

