



Technical Spezification

miniature terminal blocks, 2 conductors with fixing flanges, it's a wago style modular terminal blocks with cage clamp connection, and equivalent with wago 260 series terminal blocks and can be compatible with wago's.

Conductors	4
Wire Range:	0,2~1,5mm"
Wire Range	24~16 AWG
Rated Voltage:	400V (IEC), 300V(UL)
Rated Current:	18A(IEC) 10A(UL)
Insulating Material:	Nylon PA66 (UL94,V-0 or V-2)
Spring Cage Materials:	Spring Steel
Stripping Length:	8~9mm / 0,33

Dimension

Thickness:	5,0mm
Width:	25,0mm
Height:	17,0mm
Color of Body:	Gray, Orange, Light Gray, Blue, Gren-Yellow

Drawing

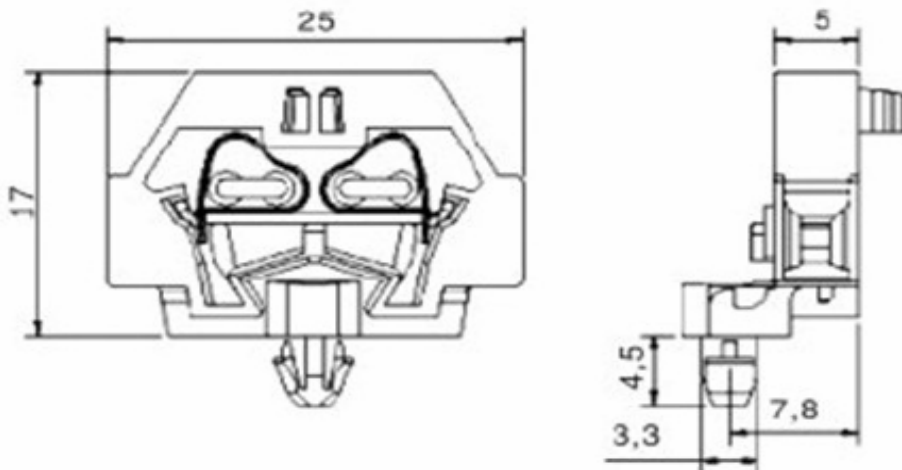

Ordering Information

Serie	Color of Body	ROHS	Packing			
A29044	GY	R	BX			

GY= Gray	R= ROHS Conform	BU= Bulk-Ware
OR= Orange	N= NON ROHS Conform	BX= Box Packing
LG= Light gray		
BL= Blue		IV= Individuel Packing
GY= Green Yellow		

Mini Terminal Block	
Part No.:	A29044
Customer:	

DRW:	Jason	CHKD	Wilson	MATL:	Wilson	DATE	18.08.2011
APPD:	Schumi			FINISH	Jamy	Sheet	1 from 1

