



General Characteristics	
Operating Temperature:	. -25°C ~ +70°C
Capacitance Tolerance:	. -20% ~ +80%
Rated Voltage:	5,5Volt
Surge Voltage:	6,0Volt
Capacitance:	0,10F
Nominal Impedance AC:	75 Ω
Nominal Impedance DC:	110 Ω
Storage Temperature:	. -40°C ~ +85°C
Cycle Life:	Standard charge - discharge mode > 100000 cycles, ΔC/C ≤30%, ESR ≤ 4 times of spezified ESR

Environmental Characteristics	
Item	Specification / Condition
Temperature Characteristics	ΔC/C ≤30%, ESR ≤ spezified ESR (25°C) at + 70°C ΔC/C ≤50%, ESR ≤ 4 times of spezified ESR (25°C) at -25°C
High temperature load	ΔC/C ≤30%, ESR ≤ 4 times of spezified ESR (25°C) at +70±2°C/1000hrs/rated voltage
High temperature storage	ΔC/C ≤30%, ESR ≤ 2 times of spezified ESR (25°C) at +70±2°C/1000hrs/standby after fully charge.
Humidity Resistance	. +40°C±2, 90-95%RH, 250h, ΔC/C ≤30% IL ≤ 2 times of specified leakage current, ESR ≤ 4times of specified ESR (25°C)

This product specification describes the characteristics of coin-type supercapacitor produced by EDCON-COMPONENTS

Standard Testing Condition

All test and measurements shall be made under standard atmospheric conditions(Temperature: 15~35, Relative humidity: 25%~75%)for testing. Before the measurements are made, the supercapacitor shall be store at the measuring temperature for a time sufficient to allow the entire supercapacitor to reach this temperature. All tests of the specification book were carried out under the following environmental conditions□ Temperature: 25±1□ Humidity:□60±15□□RH Air pressure□86~106KPa

Drawing

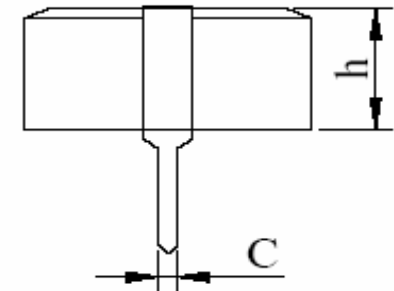
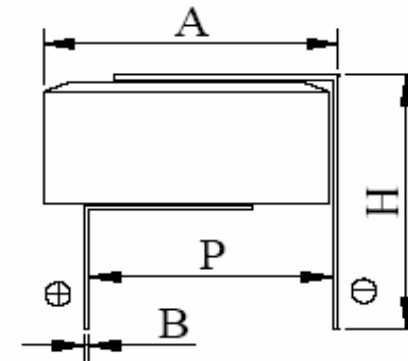
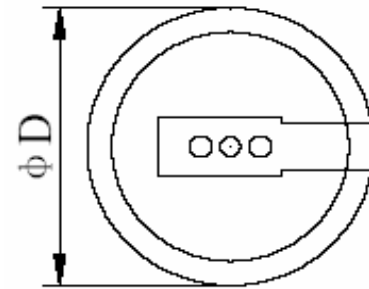

Item	Dimension (mm)
D	11,5 ± 0,5mm
h	4,5 ± 0,5mm
A	12,4 ± 0,5mm
C	0,8 ± 0,1mm
H	10,5 ± 0,5mm
P	10,5 ± 0,5mm
B	0,20 ± 0,05mm

Goldcap Supercapacitor Type H

Serie No.: **I33016**

DRW:	Jason	CHKD	Wilson	MATL:	Wilson	TOLERANCE	Mason	DATE	27.05.2011	Customer:
APPD:	Schumi			FINISH	Jamy		Sheet No.	1 from 6		



Product Specification

The Measurement Methods

Capacitance: (Constant current discharge method)

A Turn the switch S to the DC power supply, charge the supercapacitor with constant current (general 5mA) to rated voltage (U_R):

B Constant voltage charge at rated voltage (U_R) for 30min.;

C Discharge the supercapacitor with constant current (general 5mA) to 0,1V.

Measure the time t_1 to t_2 where the voltage between capacitor terminals at the time of discharge reduces from U_1 to U_2 as shown figure 2 and calculate the capacitance value by the following formula.

$$C = \frac{I \times (t_2 - t_1)}{U_1 - U_2}$$

where:

- C: is the capacitance (F)
- I: is the discharge current (A)
- t_1 : is the time from discharge start to reach U_1 (s)
- t_2 : is the time from discharge start to reach U_2 (s)
- U_1 : is the measurement starting voltage (V)
- U_2 : is the measurement end voltage (V)

Circuit for constant current discharge method

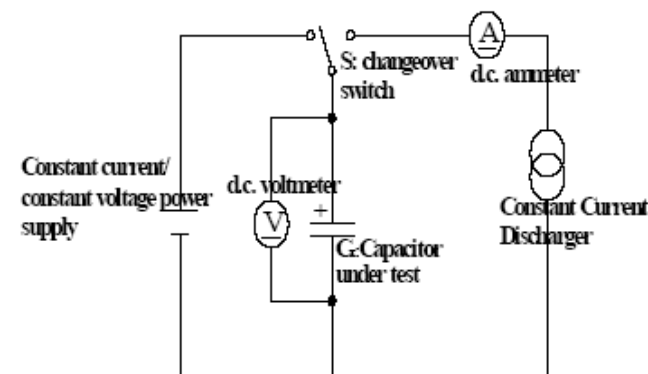

Curve for charge - discharge

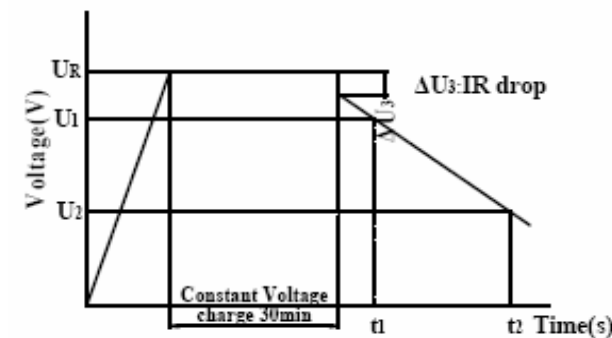

**Goldcap Supercapacitor
Type H**

Serie No.: **I33016**

Customer:

DRW:	Jason	CHKD	Wilson	MATL:	Wilson	TOLERANCE	Mason	DATE	27.05.2011
APPD:	Schumi			FINISH	Jamy		Sheet No.	2 from 6	

EDCON-COMPONENTS



Product Specification

Internal resistance:

DC resistance method

$$R_{DC} = \frac{U_3}{I}$$

where: R_{DC} : is the DC internal resistance (Ω)

U_3 : is the drop voltage for 10ms (V)

I : is the discharge current (A)

AC resistance method

Measure AC internal resistance by the LCR meter (Frequency: 1KHz)

The internal resistance R_{AC} of a supercapacitor shall be calculated by the following formula:

$$R_{AC} = \frac{U}{I}$$

where: R_{AC} is the internal resistance (Ω)

U : is the effective value of AC voltage (V r.m.s.)

I : is the effective value of AC current (A r.m.s.)

Leakage current

Before this measurement is made, the capacitor shall be fully discharge.

Discharge procedure shall take more than 1h:

Apply rated voltage to the supercapacitor:

Measure U_V after 20min, 12h, 24h, 72h,

Calculator current using the following formula:

where:

$$LC = \frac{U_V}{R} \times 10^3 \text{ mA}$$

LC : is the leakage current (ma)

UV : is the voltage between capacitor terminals (V)

R : is the protective resistor of 1000 Ω or less (Ω)

Circuit for AC internal resistance method

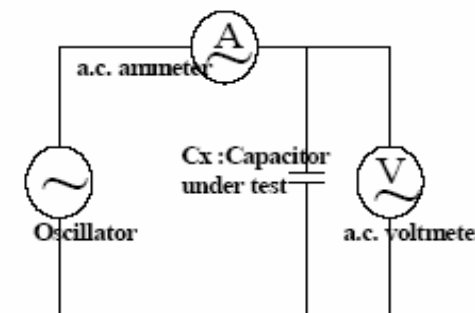

Circuit for leakage current method

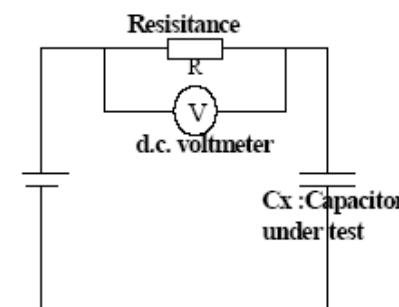

**Goldcap Supercapacitor
Type H**

Serie No.: **I33016**

Customer:

DRW:	Jason	CHKD	Wilson	MATL:	Wilson	TOLERANCE	Mason	DATE	27.05.2011
APPD:	Schumi			FINISH	Jamy		Sheet No.		3 from 6

EDCON-COMPONENTS



Handling Precautions and Guidelines

For safety application, please contact Lampson directly for any technical specifications, handling precautions and guidelines critical to application.

Precautions

Prohibition of disassembly

The disassembling may generate internal short circuit in the cell, which may cause gassing, leakage, explosion, or other problems.

Electrolyte is harmful: In case the electrolyte come into contact with the skin, or eyes, physicians shall flush the electrolyte immediately with fresh water and medical advice is to be sought.

Prohibition of dumping of cells into fire

These may cause explosion of the cells, which is very dangerous and is prohibited.

Prohibition of cells immersion into liquid

The cells shall never be soaked with liquids such as water, seawater, drinks such as juices, coffee or others.

Prohibition of use of damaged cells

The cells might be damaged during shipping by shock. If any abnormal features of the cells are found such as damages in the cell package, smelling of an electrolyte, an electrolyte leakage and others, the cells shall never be used any more.

The Cells with a smell of the electrolyte or a leakage shall be placed away from fire to avoid firing or explosion.

Handling Guidelines

It is not suitable that cell is used under such conditions: AC circuit and wave filtering.

Work voltage of cell should not exceed Max. work voltage of cell during using. Otherwise, will shorten shelf life, even cause swelling, leakage or crack..

Please check the polarity before using. If working under reverse polarity, cell will not only shorten shelf life, but also heavy damage, such as swelling, electrolyte leakage etc.

Environment

Work temperature will have an influence on shelf life of cell. As usual, higher work temperature will shorten shelf life. So, it is better that cell works under as possible as low environmental temperature. Work temperature of cell should consider internal work temperature in the unit and temperature rise when cell works.

IR drop

When main power sources shut down, cell will change into work mode from failure mode, at the same time, OCV will decrease due to IR drop. So please choose proper product type according to impedance specified in product datasheet and applied current.

Cells in series connection

When cells in series connection for higher work voltage, it should be assured that work voltage of any single cell must not exceed Max. work voltage of single cell, otherwise, will shorten shelf life, even cause swelling, leakage or crack.

Soldering

Heat shock will decrease electric performance of cell, even cause swelling, leakage or crack.

Soldering temperature should not exceed 230°C, soldering time should not exceed 5s.

**Goldcap Supercapacitor
Type H**

Serie No.: **I33016**

DRW:	Jason	CHKD	Wilson	MATL:	Wilson	TOLERANCE	Mason	DATE	27.05.2011	Customer:
APPD:	Schumi			FINISH	Jamy		Sheet No.	4 from 6		

EDCON-COMPONENTS



Handling Precautions and Guidelines

Please don't use reflow soldering of infrared heating and air heating.

Ordering Informations

Serie	Voltage	Capacitance	Capacitance	ROHS	Packing					
I33016	055	Z	1010	R	TY					

055 = 5,5Volt	Z = -20° ~ +80%	1010 = 0,10F	R = ROHS Conform	TY = Tray Packing
				IV = Individual Packing

**Goldcap Supercapacitor
Type H**

Serie No.: **I33016**

DRW:	Jason	CHKD	Wilson	MATL:	Wilson	TOLERANCE	Mason	DATE	27.05.2011
APPD:	Schumi			FINISH	Jamy		Sheet No.		5 from 6

Customer:

www.edcon-components.com

email: info@edcon-components.com



Soldering Profile Curve

Classification Reflow Profile (JEDEC J-STD-020C)

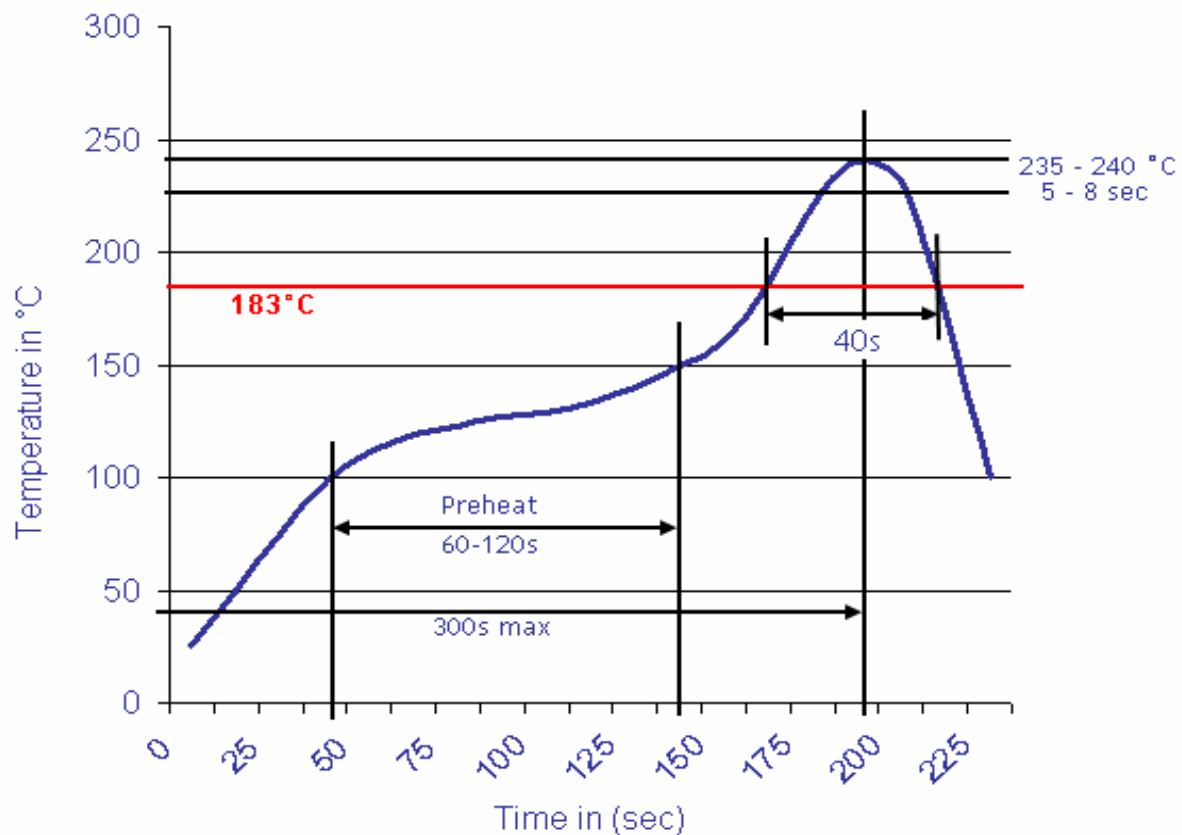

**Goldcap Supercapacitor
Type H**

Serie No.: **I33016**

Customer:

DRW:	Jason	CHKD	Wilson	MATL:	Wilson	TOLERANCE	Mason	DATE	27.05.2011
APPD:	Schumi			FINISH	Jamy		Sheet No.	6 from 6	