

EDCON-COMPONENTS

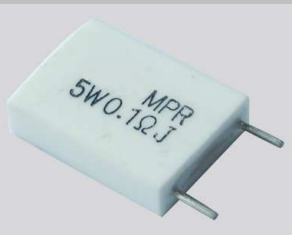

Technical Description

Temperature Coefficient:	± 350PPM/°C
Short Time Overload:	± (2% +0,05Ω)Max., with no evidence of mechanical damage
Dielectric Withstanding Voltage:	2000 Volt
Terminal Strength:	No evidence of mechanical damage
Resistance to Soldering Heat:	± (1,0% + 0,05Ω)Max. with no evidence of mechanical damage
Solderability:	Min. 95% coverage
Temperature Cycling:	± (5% +0,05Ω)Max., with no evidence of mechanical damage
Humidity Cycling:	± (5% +0,05Ω)Max., with no evidence of mechanical damage
Load Life in Humidity:	± (5% +0,05Ω)Max., with no evidence of mechanical damage
Load Life:	± (5% +0,05Ω)Max., with no evidence of mechanical damage

Drawing

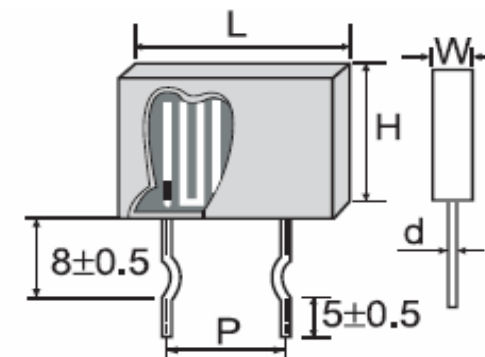

Features

Low Inductance; Safety flameproof construction; Thin & lightweight save PCB space
 Low temperature coefficient, low noise, high load power, high insulating
 Automatically insertable; Application TV, Microwave, Audio,

Dimension (mm)

W +0 -0,5	H ±1	L ±1	d ±0,5	P ±1
5,0	8,5	14,0	0,8	9,0

Derating Curve

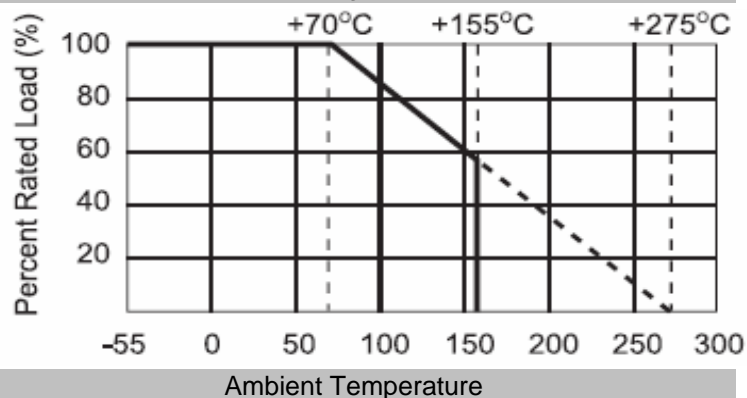

Heat Rise Chart

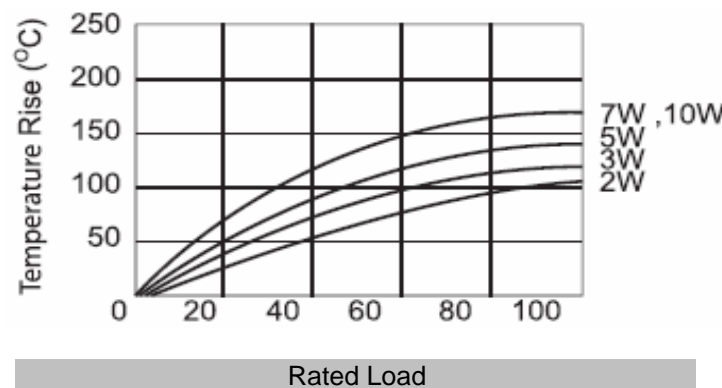

2Watt Power Flat Alloy Resistor (non-inductiv)

Part No.: **X48001**

DRW:	Jason	CHKD	Wilson	MATL:	Wilson	TOLERANCE	Mason	DATE	21.03.2011	Customer:
APPD:	Schumi			FINISH	Jamy		Sheet No.	1 from 3		

EDCON-COMPONENTS

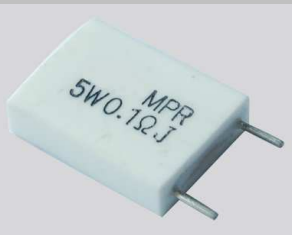

Resistance Range Tol. 5% & 10%
0,01 ~ 0,68 Ω

Operating Temperature
-55°C ~ +275°C

Ordering Informations

Serie	Range Code	Tolerance Code	Lead Style	Lead Option	ROHS	Packing				
X48001	0R01	K	A	A	R	BU				

0R01 = 0,01Ω look Range	K = ±10%	A = Straight Lead	A = Lead Length 14mm	R = ROHS Conform	BU = Bulk-Ware
	J = ±5%	B = Kinked Lead	B = Lead Length 7mm	N = NON ROHS Conform	
			C = Lead Length 3,5mm		

2Watt Power Flat Alloy Resistor (non-inductiv)

Part No.: **X48001**

DRW:	Jason	CHKD	Wilson	MATL:	Wilson	TOLERANCE	Mason	DATE	21.03.2011	Customer:
APPD:	Schumi			FINISH	Jamy		Sheet No.	2 from 3		

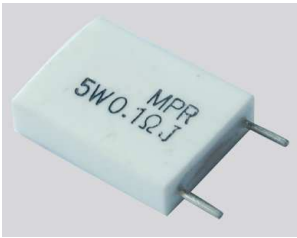

Soldering Profile Curve

Classification Reflow Profile (JEDEC J-STD-020C)

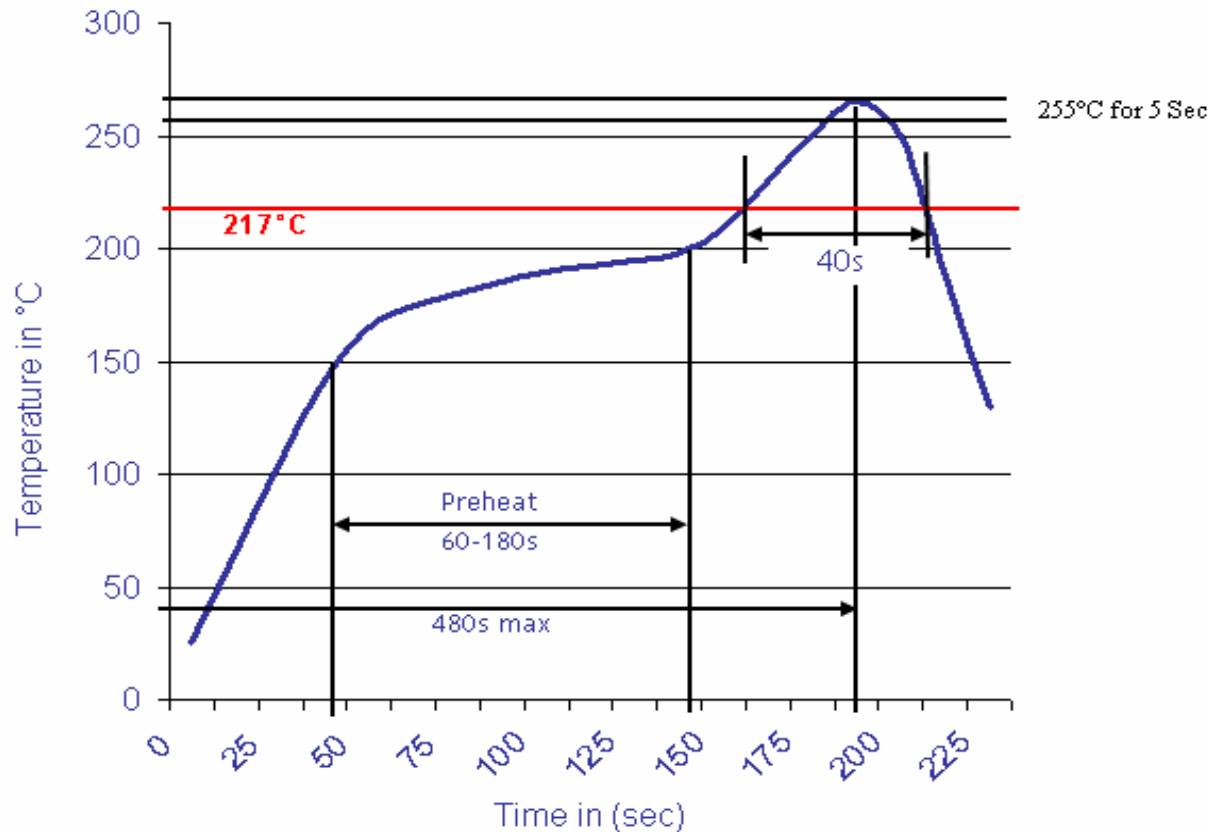

2Watt Power Flat Alloy Resistor (non-inductiv)	
Part No.:	X48001
Customer:	

DRW:	Jason	CHKD	Wilson	MATL:	Wilson	TOLERANCE	Mason	DATE	21.03.2011
APPD:	Schumi			FINISH	Jamy		Sheet No.		3 from 3

www.edcon-components.com

email: info@edcon-components.com