



DATA SHEET

Lithium Coin Cell Type CR-2016

Serie: B20009

Lithium Coin Cell Type CR-2016

Serie No.: **B20009**

Customer:

DRW:	Jason	CHKD	Wilson	MATL:	Wilson	TOLERANCE	Mason	DATE	25.01.2011
APPD:	Schumi			FINISH	Jamy		Sheet No.		1 from 6

EDCON-COMPONENTS



Specifications

Nominal Voltage	3,0 Volt
Nominal Capacity	75 (mAH)
Continuous standard load	30 (KΩ)
Operating Temperature	. -20 ~ + 60°C
Weight	1,6 gr.

Dimensions (mm)

A	Ø 17,5
B	Ø 20,0 / +0,0 -0,3
C	1,2
D	1,6 / +0.0 -0,3

Lead Style 01

Technical Drawing

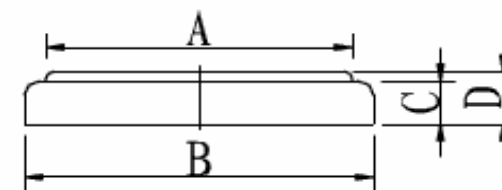
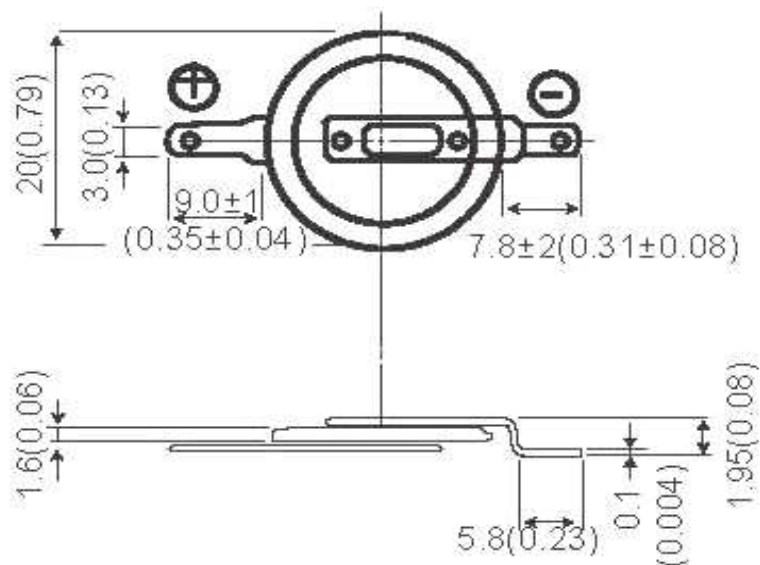

Lithium Coin Cell Type CR-2016

Part No.: **B20009**

Customer:

DRW:	Jason	CHKD	Wilson	MATL:	Wilson	TOLERANCE	Mason	DATE	25.01.2011
APPD:	Schumi			FINISH	Jamy		Sheet No.	2 from 6	

EDCON-COMPONENTS



Characteristics Curve

Discharge characteristics

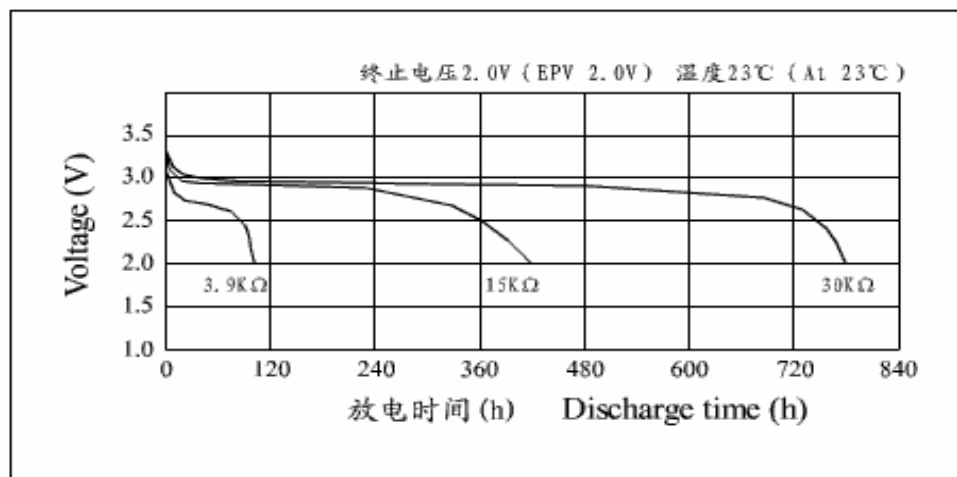

Temperature Characteristics

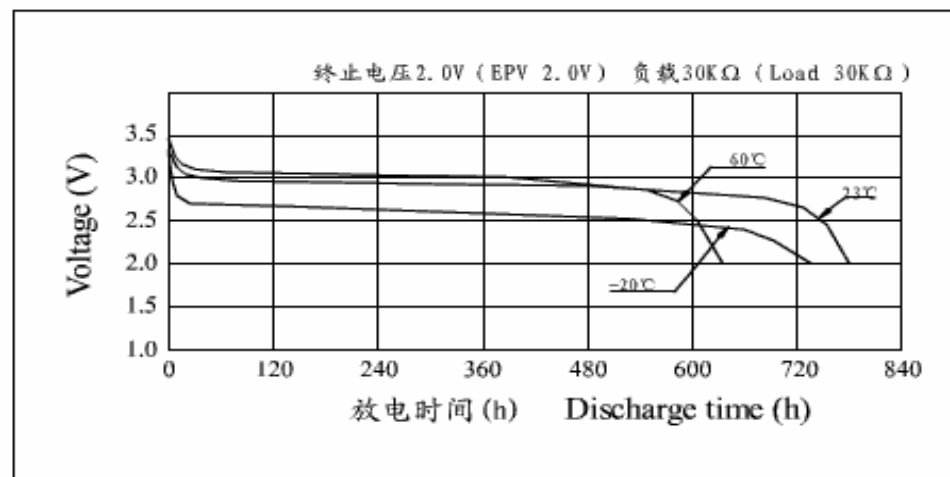

Lithium Coin Cell Type CR-2016

Part No.: **B20009**

Customer:

DRW:	Jason	CHKD	Wilson	MATL:	Wilson	TOLERANCE	Mason	DATE	25.01.2011
APPD:	Schumi			FINISH	Jamy		Sheet No.	3 from 6	

EDCON-COMPONENTS



Characteristics Curve

Load vs Operating Voltage

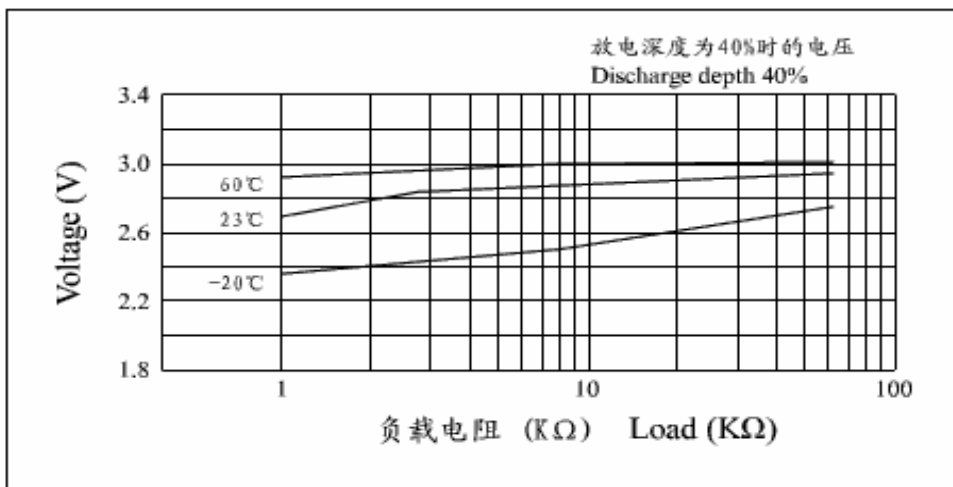

Load vs. Capacity

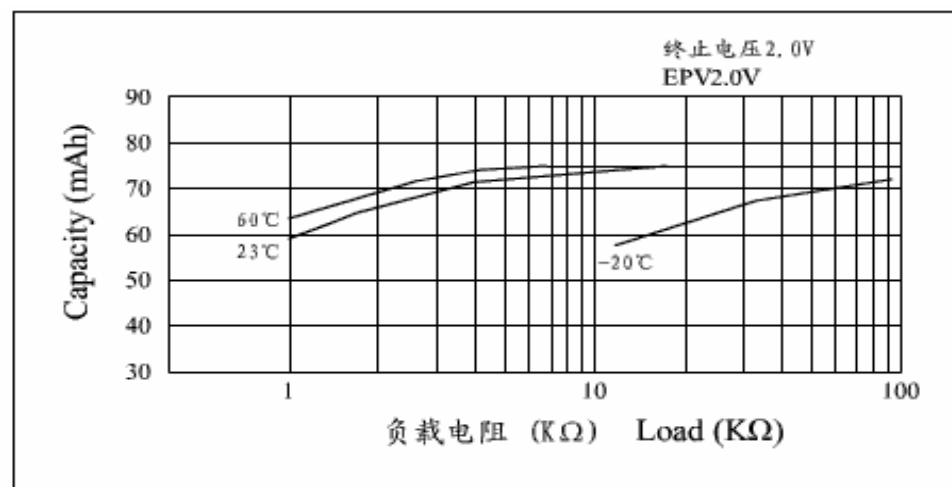

Lithium Coin Cell Type CR-2016

Part No.: **B20009**

DRW:	Jason	CHKD	Wilson	MATL:	Wilson	TOLERANCE	Mason	DATE	25.01.2011
APPD:	Schumi			FINISH	Jamy		Sheet No.	4 from 6	Customer:

EDCON-COMPONENTS



Characteristics Curve

Pulse discharge characteristics

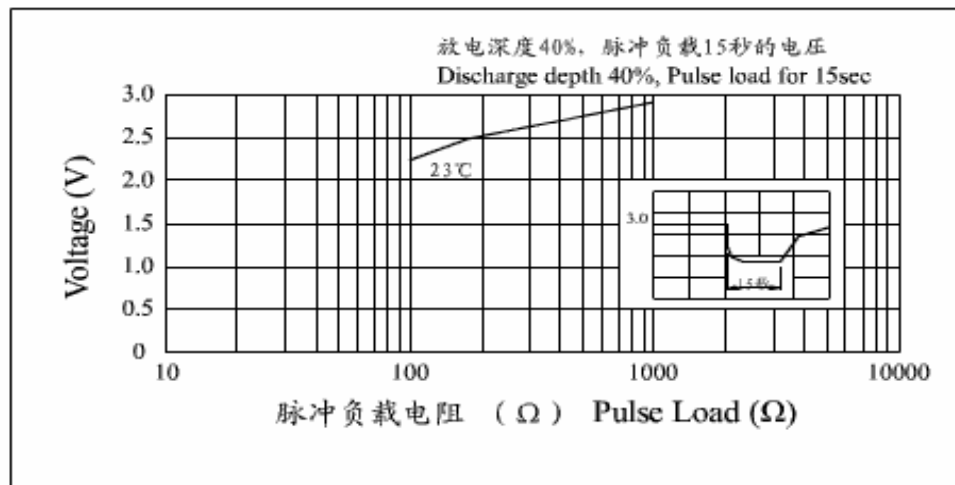

Storage characteristics

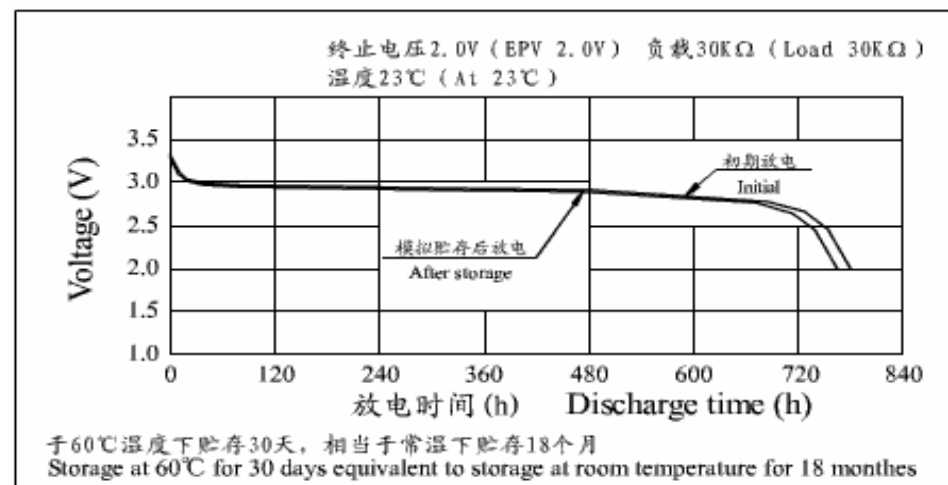

Lithium Coin Cell Type CR-2016

Part No.: **B20009**

DRW:	Jason	CHKD	Wilson	MATL:	Wilson	TOLERANCE	Mason	DATE	25.01.2011	Customer:
APPD:	Schumi			FINISH	Jamy		Sheet No.	5 from 6		

EDCON-COMPONENTS



Ordering Informations

Serie	Type of Battery	Battery Size	Lead Style	No function	ROHS	Packing Code				
-------	-----------------	--------------	------------	-------------	------	--------------	--	--	--	--

B20009	-	CR	2016	01	0	R	IP			
---------------	---	-----------	-------------	-----------	----------	----------	-----------	--	--	--

CR= NON Rechargeable Lithium	Diameter * Thickness	00= NO function	0= NO function	R= ROHS Conform N= NON ROHS Conform	IP= Industrial Package
		01= Lead Style			TY= Tray Package
					B1= Blister 1 Pcs
					B5= Blister 5 Pcs
					CU= Customer Special

Lithium Coin Cell Type CR-2016

Part No.: **B20009**

Customer:

DRW:	Jason	CHKD	Wilson	MATL:	Wilson	TOLERANCE	Mason	DATE	25.01.2011
APPD:	Schumi			FINISH	Jamy		Sheet No.		6 from 6