



# DATA SHEET

## Lithium Coin Cell Type CR-1616

### Serie: B20006

Lithium Coin Cell Type CR-1616

Serie No.: **B20006**

Customer:

DRW:	Jason	CHKD	Wilson	MATL:	Wilson	TOLERANCE	Mason	DATE	25.01.2011
APPD:	Schumi			FINISH	Jamy		Sheet No.		1 from 6

# EDCON-COMPONENTS



## Specifications

Nominal Voltage	3,0 Volt
Nominal Capacity	50 (mAh)
Continuous standard load	30 (KΩ)
Operating Temperature	. -20 ~ + 60°C
Weight	1,2 gr.

## Dimensions (mm)

A	Ø 13,8
B	Ø 16,0 / +0,0 -0,2
C	1,3
D	1,6 / +0,0 -0,3

## Lead Style 1

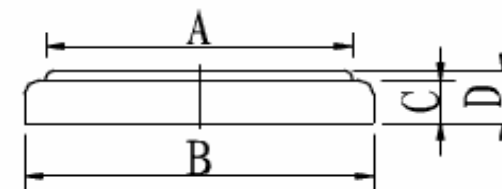
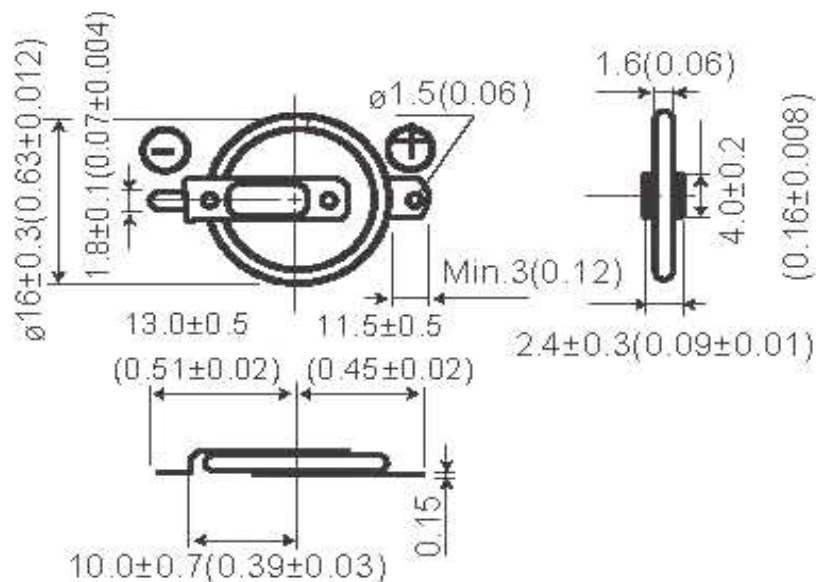

## Technical Drawing

Lithium Coin Cell Type CR-1616

Part No.: **B20006**

Customer:

DRW:	Jason	CHKD	Wilson	MATL:	Wilson	TOLERANCE	Mason	DATE	25.01.2011
APPD:	Schumi			FINISH	Jamy		Sheet No.	2 from 6	



## Characteristics Curve

### Discharge characteristics

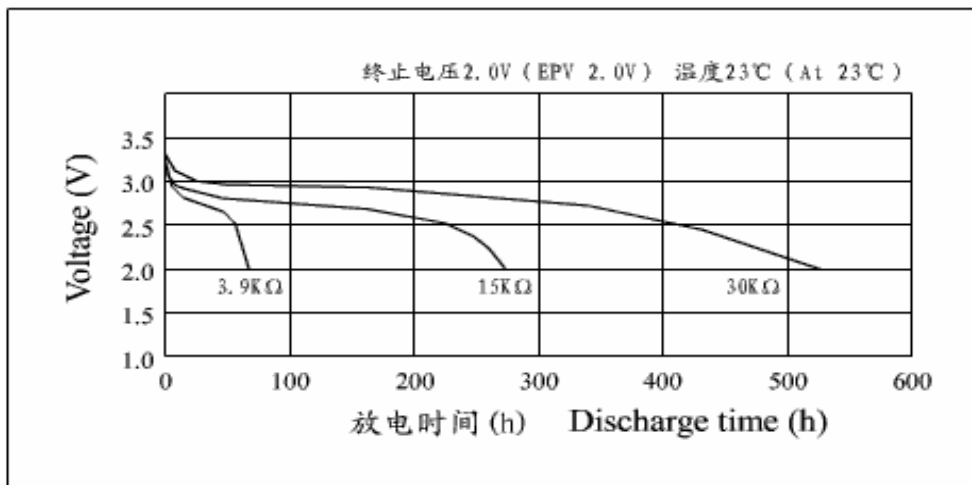

### Temperature Characteristics

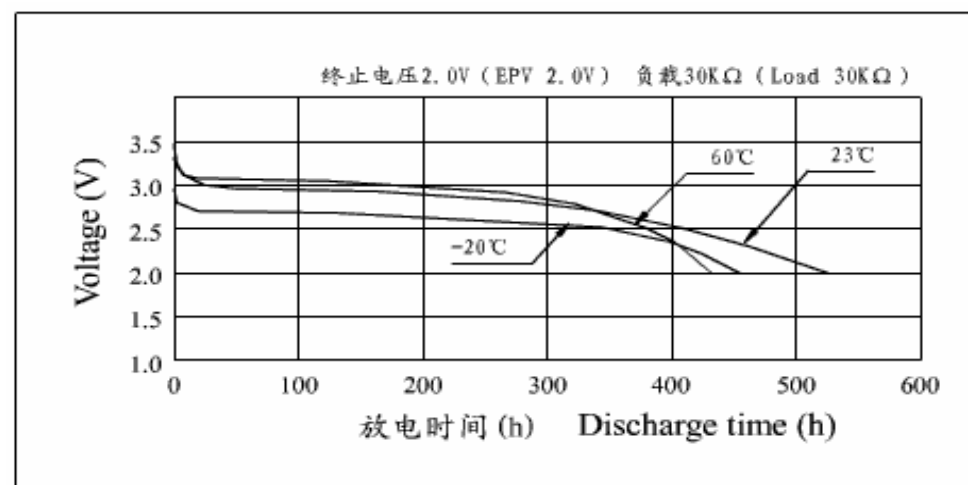

Lithium Coin Cell Type CR-1616

Part No.: **B20006**

Customer:

DRW:	Jason	CHKD	Wilson	MATL:	Wilson	TOLERANCE	Mason	DATE	25.01.2011
APPD:	Schumi			FINISH	Jamy		Sheet No.	3 from 6	



## Characteristics Curve

### Load vs Operating Voltage

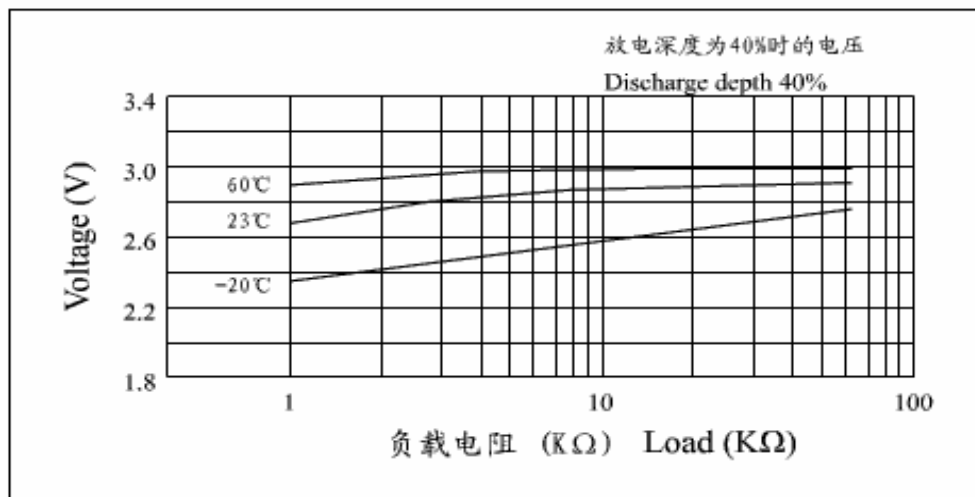

### Load vs. Capacity

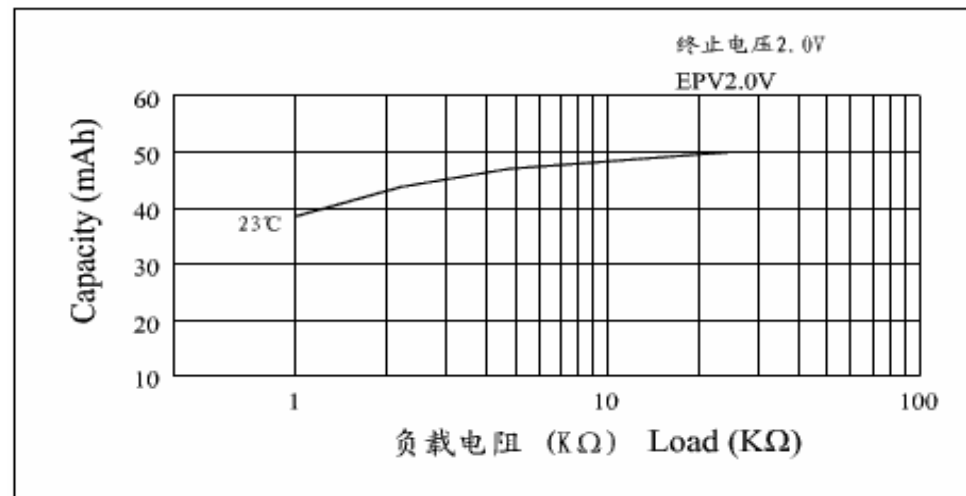

Lithium Coin Cell Type CR-1616

Part No.: **B20006**

DRW:	Jason	CHKD	Wilson	MATL:	Wilson	TOLERANCE	Mason	DATE	25.01.2011
APPD:	Schumi			FINISH	Jamy		Sheet No.	4 from 6	Customer:

# EDCON-COMPONENTS



## Characteristics Curve

### Pulse discharge characteristics

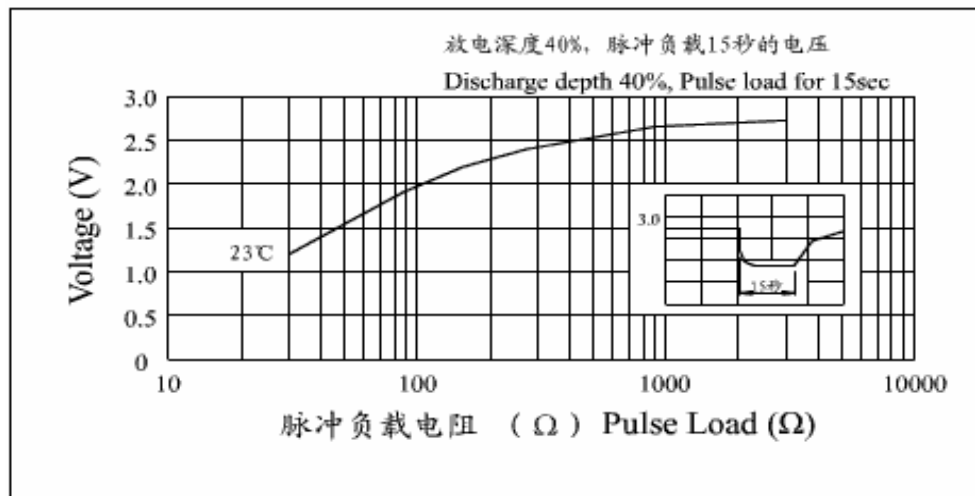

### Storage characteristics

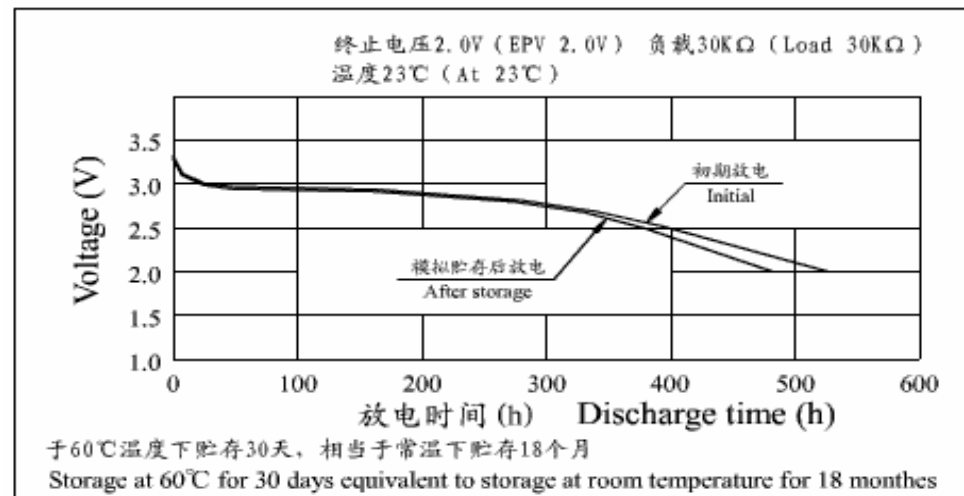

Lithium Coin Cell Type CR-1616

Part No.: **B20006**

DRW:	Jason	CHKD	Wilson	MATL:	Wilson	TOLERANCE	Mason	DATE	25.01.2011	Customer:
APPD:	Schumi			FINISH	Jamy		Sheet No.	5 from 6		

# EDCON-COMPONENTS



## Ordering Informations

Serie	Type of Battery	Battery Size	Lead Style	No function	ROHS	Packing Code				
-------	-----------------	--------------	------------	-------------	------	--------------	--	--	--	--

<b>B20006</b>	-	<b>CR</b>	<b>1616</b>	<b>01</b>	<b>0</b>	<b>R</b>	<b>IP</b>			
---------------	---	-----------	-------------	-----------	----------	----------	-----------	--	--	--

<b>CR= NON Rechargeable Lithium</b>	Diameter * Thickness	<b>00= NO function</b>	<b>0= NO function</b>	<b>R= ROHS Conform</b> <b>N= NON ROHS Conform</b>	<b>IP= Industrial Package</b>
		<b>01= Lead Style</b>			<b>TY= Tray Package</b>
					<b>B1= Blister 1 Pcs</b>
					<b>B5= Blister 5 Pcs</b>
					<b>CU= Customer Special</b>

**Lithium Coin Cell Type CR-1616**

Part No.: **B20006**

Customer:

DRW:	Jason	CHKD	Wilson	MATL:	Wilson	TOLERANCE	Mason	DATE	25.01.2011
APPD:	Schumi			FINISH	Jamy		Sheet No.	6 from 6	