

EDCON-COMPONENTS

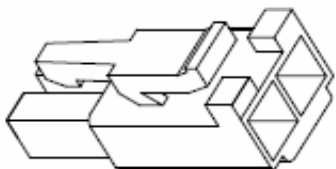

Technical Discription

Material: Nylon 66 UL94 V-2
No. of Positions: 1x2Pos.
Type of Housing: Plug
Current Rating: 4A AC/DC
Voltage Rating: 250V AC/DC
Temperature Range: -25°C ~ +85°C
Contact Resistance: Initial Value/10mΩ max.
After environmental testing: 20mΩ max.
Insulation Resistance: 500MΩ min.
Withstanding Voltage: 1500V AC/minute
Applicable Wire: AWG18~22

Drawing

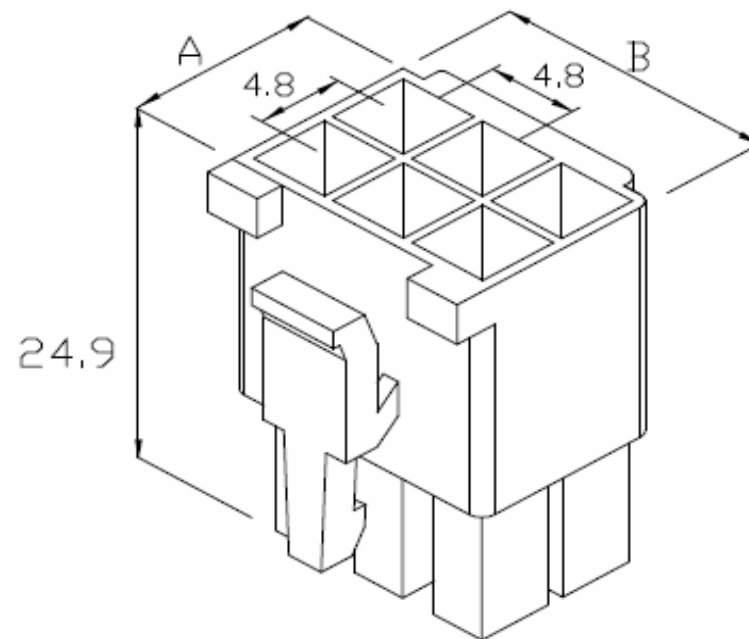
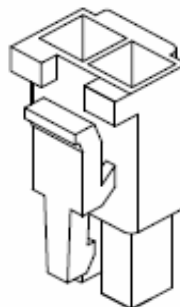

Item-No.		Dimension (mm)	
		A	B
T70V012	2Pos.	7,2	12,0
T70V013	3Pos.	7,2	16,8
T70V014	4Pos.	7,2	21,6
T70V015	2x3Pos.	12,0	16,8
T70V016	3x3Pos.	16,8	16,8
T70V017	3x4Pos.	16,8	21,6
T70V018	3x5Pos.	16,8	26,4

Wire to Wire Connector	
Pitch 4,80mm	
Part No.:	T70V012
Customer:	

DRW:	Jason	CHKD	Wilson	MATL:	Wilson	TOLERANCE	Mason	DATE	30.10.2010
APPD:	Schumi			FINISH	Jamy		Sheet No.		1 from 2

EDCON-COMPONENTS

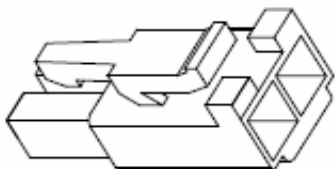

Ordering Informations

Serie	ROHS	Packing				
T70V012	R	BU				

R= ROHS Conform	BU= Bulk-Ware
N= NON ROHS Conform	

Wire to Wire Connector Pitch 4,80mm	
Part No.:	T70V012
Customer:	

DRW:	Jason	CHKD	Wilson	MATL:	Wilson	TOLERANCE	Mason	DATE	30.10.2010
APPD:	Schumi			FINISH	Jamy			Sheet No.	2 from 2