

EDCON-COMPONENTS

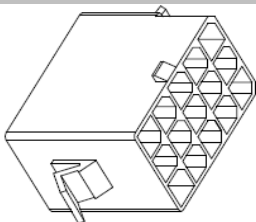

Technical Discription

Material: Nylon 66 UL94 V-2
No. of Positions: 3x5Pos.
Type of Housing: Plug
Current Rating: 4A AC/DC
Voltage Rating: 250V AC/DC
Temperature Range: -25°C ~ +85°C
Contact Resistance: Initial Value/10mΩ max.
After environmental testing: 20mΩ max.
Insulation Resistance: 500MΩ min.
Withstanding Voltage: 1500V AC/minute
Applicable Wire: AWG18~22

Drawing

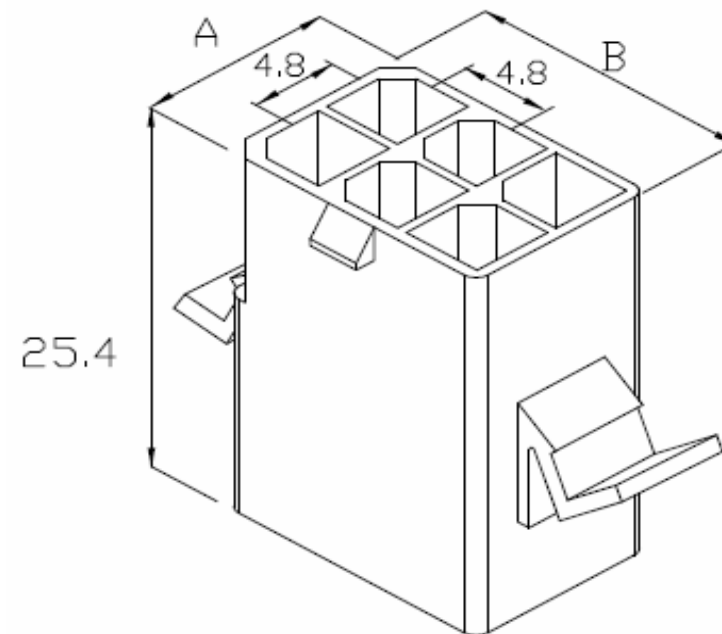
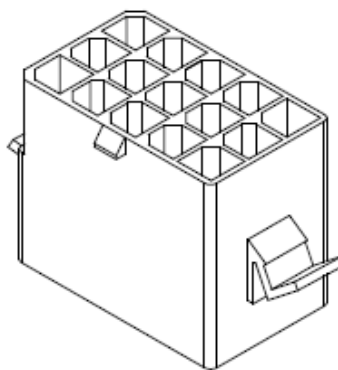

Item-No.		Dimension (mm)	
		A	B
T70V003	2Pos.	7,2	12
T70V004	3Pos.	7,2	16,8
T70V005	4Pos.	7,2	21,6
T70V006	2x3Pos.	12,0	16,8
T70V007	3x3Pos.	16,8	16,8
T70V008	3x4Pos.	16,8	21,6
T70V009	3x5Pos.	16,8	26,4

Wire to Wire Connector Pitch 4,80mm	
Part No.:	T70V009
Customer:	

DRW:	Jason	CHKD	Wilson	MATL:	Wilson	TOLERANCE	Mason	DATE	30.10.2010
APPD:	Schumi			FINISH	Jamy		Sheet No.		1 from 2

www.edcon-components.com

email: info@edcon-components.com

EDCON-COMPONENTS

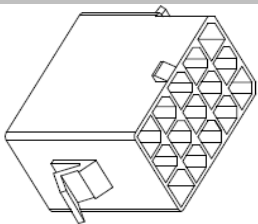

Ordering Informations

Serie	ROHS	Packing				
-------	------	---------	--	--	--	--

T70V009	-	R	BU			
---------	---	---	----	--	--	--

R= ROHS Conform	BU= Bulk-Ware
N= NON ROHS Conform	

Wire to Wire Connector Pitch 4,80mm	
Part No.:	T70V009
Customer:	

DRW:	Jason	CHKD	Wilson	MATL:	Wilson	TOLERANCE	Mason	DATE	30.10.2010
APPD:	Schumi			FINISH	Jamy		Sheet No.		2 from 2