

EDCON-COMPONENTS

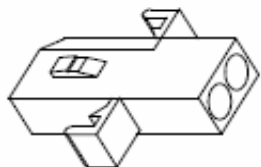

Technical Discription

Material: Nylon 66 UL94 V-2
 No. of Positions: 1x2Pos.
 Type of Housing: Receptacle
 Mates with Terminal:

Drawing

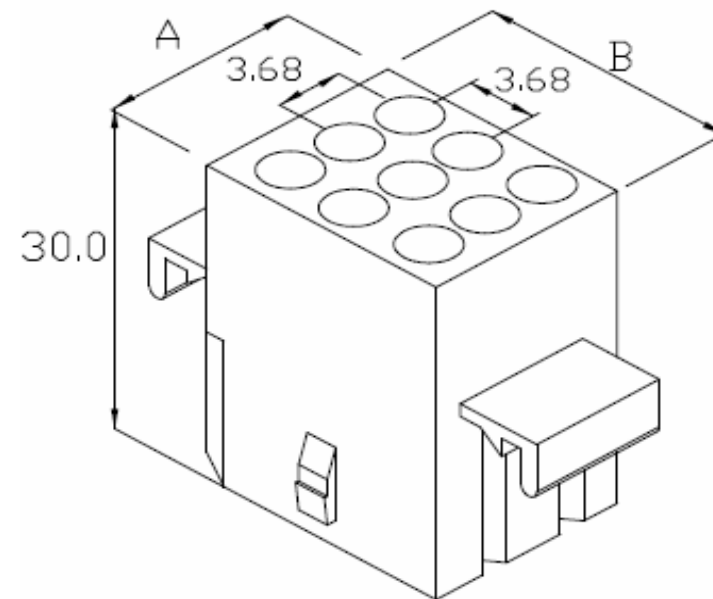
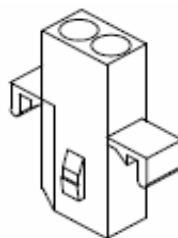

Item-No.		Dimension (mm)	
		A	B
T70U042	2Pos.	4,9	8,7
T70U043	3Pos.	4,9	12,4
T70U044	4Pos.	4,9	16,1
T70U045	5Pos.	4,9	19,7
T70U046	2x2Pos.	8,6	8,6
T70U047	2x3Pos.	12,5	8,6
T70U048	3x3Pos.	12,7	12,7
T70U049	3x4Pos.	12,7	16,8
T70U050	3x5Pos.	12,7	19,9

**Wire to Wire Connector
Pitch 3,68mm**

Part No.: **T70U042**

DRW:	Jason	CHKD	Wilson	MATL:	Wilson	TOLERANCE	Mason	DATE	30.10.2010
APPD:	Schumi			FINISH	Jamy		Sheet No.		1 from 2

Customer:
email: info@edcon-components.com

EDCON-COMPONENTS

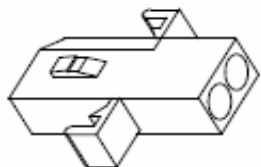

Ordering Informations

Serie	ROHS	Packing				
T70U042	R	BU				

R= ROHS Conform	BU= Bulk-Ware
N= NON ROHS Conform	

Wire to Wire Connector Pitch 3,68mm	
Part No.:	T70U042
Customer:	

DRW:	Jason	CHKD	Wilson	MATL:	Wilson	TOLERANCE	Mason	DATE	30.10.2010
APPD:	Schumi			FINISH	Jamy		Sheet No.		2 from 2