

EDCON-COMPONENTS

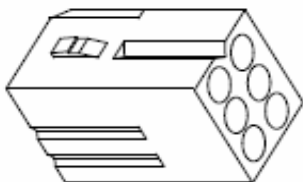

Technical Discription

Material: Nylon 66 UL94 V-2
 No. of Positions: 2x3Pos.
 Type of Housing: Receptacle
 Mates with Terminal:

Drawing

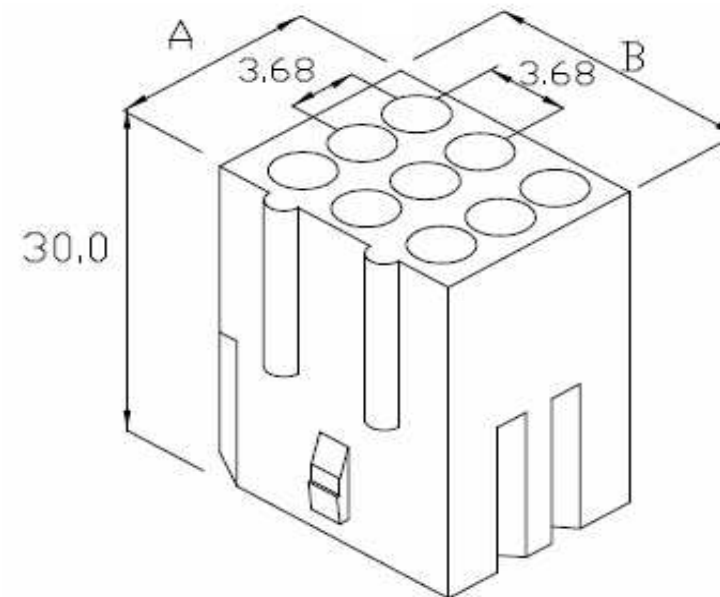
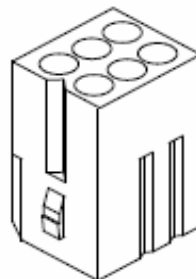

Item-No.		Dimension (mm)	
		A	B
T70U030	1Pos.	Ø 7,6	----
T70U031	2Pos.	4,9	8,7
T70U032	3Pos.	4,9	12,4
T70U033	4Pos.	4,9	16,1
T70U034	5Pos.	4,9	19,7
T70U035	2x2Pos.	8,6	8,6
T70U036	2x3Pos.	12,5	8,6
T70U037	3x3Pos.	12,7	12,7
T70U038	3x4Pos.	12,7	16,8
T70U039	3x5Pos.	12,7	19,9

Wire to Wire Connector Pitch 3,68mm	
Part No.:	T70U036
Customer:	

DRW:	Jason	CHKD	Wilson	MATL:	Wilson	TOLERANCE	Mason	DATE	30.10.2010
APPD:	Schumi			FINISH	Jamy		Sheet No.		1 from 2

www.edcon-components.com

email: info@edcon-components.com

EDCON-COMPONENTS

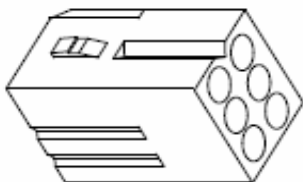

Ordering Informations

Serie	ROHS	Packing				
-------	------	---------	--	--	--	--

T70U036	-	R	BU			
---------	---	---	----	--	--	--

R= ROHS Conform	BU= Bulk-Ware
N= NON ROHS Conform	

Wire to Wire Connector Pitch 3,68mm	
Part No.:	T70U036
Customer:	

DRW:	Jason	CHKD	Wilson	MATL:	Wilson	TOLERANCE	Mason	DATE	30.10.2010
APPD:	Schumi			FINISH	Jamy		Sheet No.		2 from 2