

EDCON-COMPONENTS



Technical Discription

Material: Nylon 66 UL94 V-2
 No. of Positions: 1x5Pos.
 Type of Housing: Plug
 Mates with Terminal:

Drawing

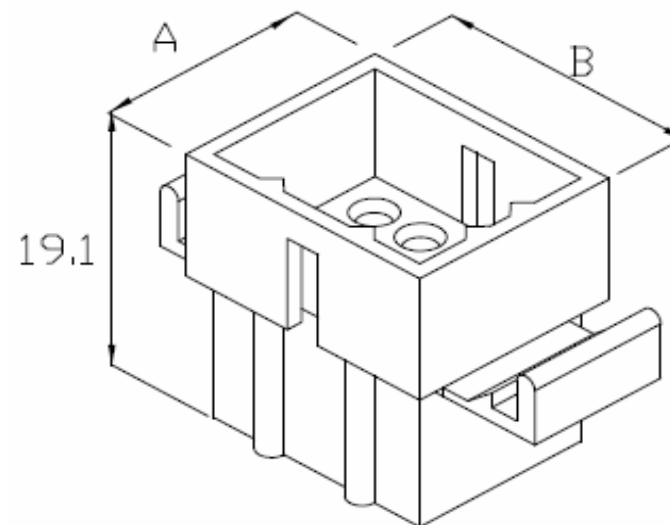
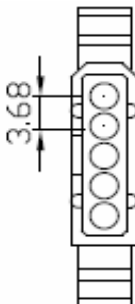

Item-No.		Dimension (mm)	
		A	B
T70U018	2Pos.	7,5	11,2
T70U019	3Pos.	7,5	14,9
T70U020	4Pos.	7,5	18,75
T70U021	5Pos.	7,9	22,5
T70U022	2x2Pos.	11,2	11,2
T70U023	2x3Pos.	15,0	11,2
T70U024	3x3Pos.	15,0	14,9
T70U025	3x4Pos.	15,0	18,7
T70U026	3x5Pos.	15,0	22,3

Wire to Wire Connector	
Pitch 3,68mm	
Part No.:	T70U021
Customer:	

DRW:	Jason	CHKD	Wilson	MATL:	Wilson	TOLERANCE	Mason	DATE	30.10.2010
APPD:	Schumi			FINISH	Jamy		Sheet No.		1 from 2

EDCON-COMPONENTS



Ordering Informations

Serie	ROHS	Packing				
T70U021	R	BU				

R= ROHS Conform	BU= Bulk-Ware
N= NON ROHS Conform	

Wire to Wire Connector Pitch 3,68mm	
Part No.:	T70U021
Customer:	

DRW:	Jason	CHKD	Wilson	MATL:	Wilson	TOLERANCE	Mason	DATE	30.10.2010
APPD:	Schumi			FINISH	Jamy		Sheet No.		2 from 2