

EDCON-COMPONENTS



Technical Discription

Material: Nylon 66 UL94 V-2
No. of Positions: 1x4Pos.
Type of Housing: Receptacle
Current Rating: 13A AC/DC
Voltage Rating: 250V AC/DC
Temperature Range: -25°C ~ +85°C
Contact Resistance: Initial Value/10mΩ max.
After environmental testing: 20mΩ max.
Insulation Resistance: 1000MΩ min.
Withstanding Voltage: 1500V AC/minute
Applicable Wire: AWG16~20

Drawing

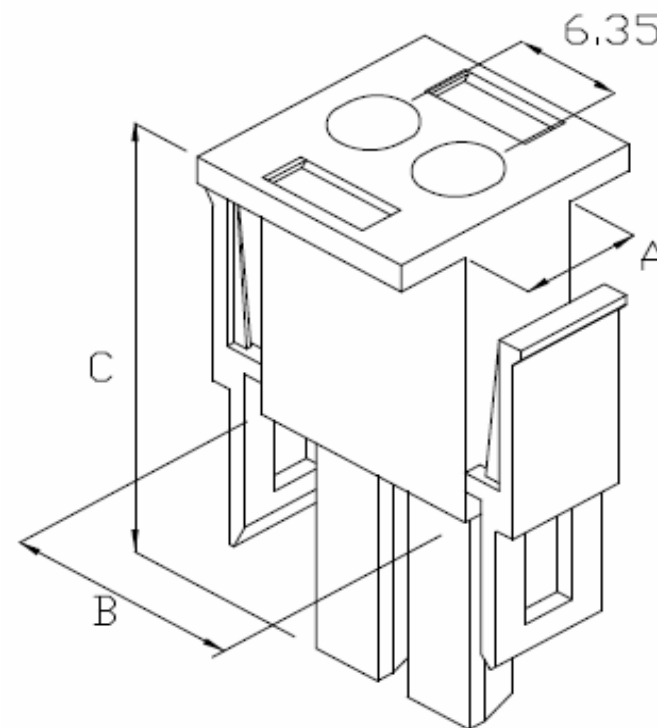
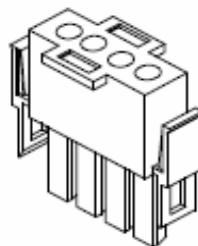

Item-No.		Dimension (mm)		
		A	B	C
T70S018	1Pos.	7,4	7,4	28,0
T70S019	2Pos.	7,6	14,0	27,4
T70S020	3Pos.	7,6	20,3	27,4
T70S021	4Pos.	7,6	26,6	27,4
T70S022	5Pos.	7,6	33,0	27,4
T70S023	2x3Pos.	20,2	14,0	27,9
T70S024	3x3Pos.	20,2	20,2	27,9
T70S025	3x4Pos.	20,2	26,7	27,9
T70S026	3x5Pos.	20,2	33,0	27,4

Wire to Wire Connector	
Pitch 6,35mm	
Part No.:	T70S021
Customer:	

DRW:	Jason	CHKD	Wilson	MATL:	Wilson	TOLERANCE	Mason	DATE	30.10.2010
APPD:	Schumi			FINISH	Jamy		Sheet No.		1 from 2

EDCON-COMPONENTS

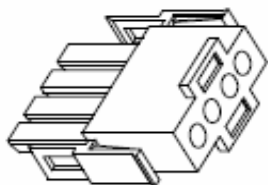

Ordering Informations

Serie	ROHS	Packing				
T70S021	R	BU				

R= ROHS Conform	BU= Bulk-Ware
N= NON ROHS Conform	

Wire to Wire Connector Pitch 6,35mm	
Part No.:	T70S021
Customer:	

DRW:	Jason	CHKD	Wilson	MATL:	Wilson	TOLERANCE	Mason	DATE	30.10.2010
APPD:	Schumi			FINISH	Jamy		Sheet No.		2 from 2