

EDCON-COMPONENTS



Technical Discription

Material: Nylon 66 UL94 V-2
No. of Positions: 1x4Pos.
Type of Housing: Receptacle
Current Rating: 2,5A AC/DC
Voltage Rating: 250V AC/DC
Temperature Range: -25°C ~ +85°C
Contact Resistance: Initial Value/10mΩ max.
After environmental testing: 20mΩ max.
Insulation Resistance: 1000MΩ min.
Withstanding Voltage: 1500V AC/minute
Applicable Wire: AWG18~22

Drawing

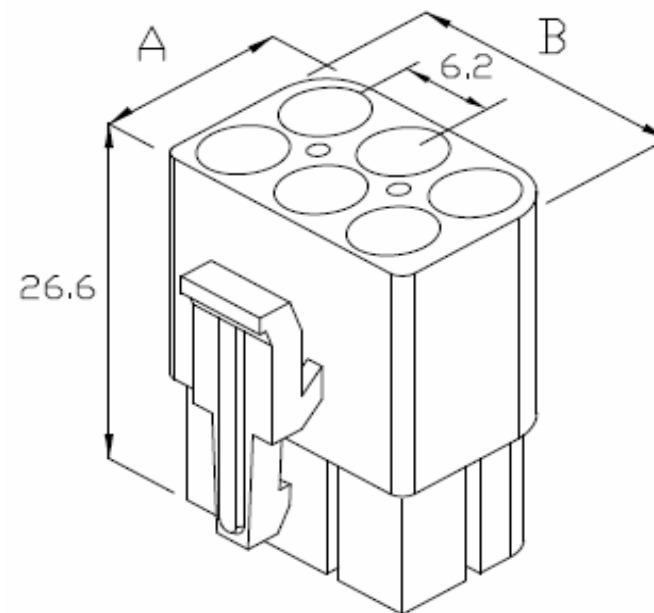
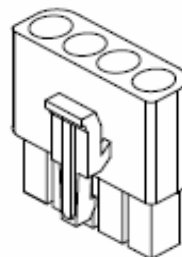

Item-No.		Dimension (mm)	
		A	B
T70R024	1Pos.	5,7	5,7
T70R025	2Pos.	7,2	13,4
T70R026	3Pos.	7,2	19,6
T70R027	4Pos.	7,2	25,8
T70R028	2x2Pos.	13,4	13,4
T70R029	2x3Pos.	13,4	19,6
T70R030	2x4Pos.	19,6	19,6
T70R031	3x4Pos.	19,6	25,8
T70R032	3x5Pos.	19,6	32,0

**Wire to Wire Connector
Pitch 6,20mm**

Part No.: **T70R027**

DRW:	Jason	CHKD	Wilson	MATL:	Wilson	TOLERANCE	Mason	DATE	30.10.2010
APPD:	Schumi			FINISH	Jamy		Sheet No.		1 from 2

Customer:
email: info@edcon-components.com

EDCON-COMPONENTS

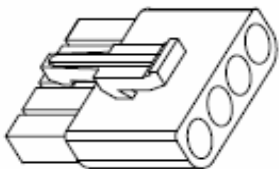

Ordering Informations

Serie	ROHS	Packing				
T70R027	R	BU				

R= ROHS Conform	BU= Bulk-Ware
N= NON ROHS Conform	

Wire to Wire Connector Pitch 6,20mm	
Part No.:	T70R027
Customer:	

DRW:	Jason	CHKD	Wilson	MATL:	Wilson	TOLERANCE	Mason	DATE	30.10.2010
APPD:	Schumi			FINISH	Jamy		Sheet No.		2 from 2