

EDCON-COMPONENTS

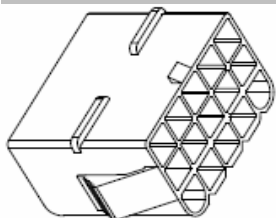

Technical Discription

Material: Nylon 66 UL94 V-2
No. of Positions: 3x5Pos.
Type of Housing: Plug
Current Rating: 2,5A AC/DC
Voltage Rating: 250V AC/DC
Temperature Range: -25°C ~ +85°C
Contact Resistance: Initial Value/10mΩ max.
After environmental testing: 20mΩ max.
Insulation Resistance: 1000MΩ min.
Withstanding Voltage: 1500V AC/minute
Applicable Wire: AWG18~22

Drawing

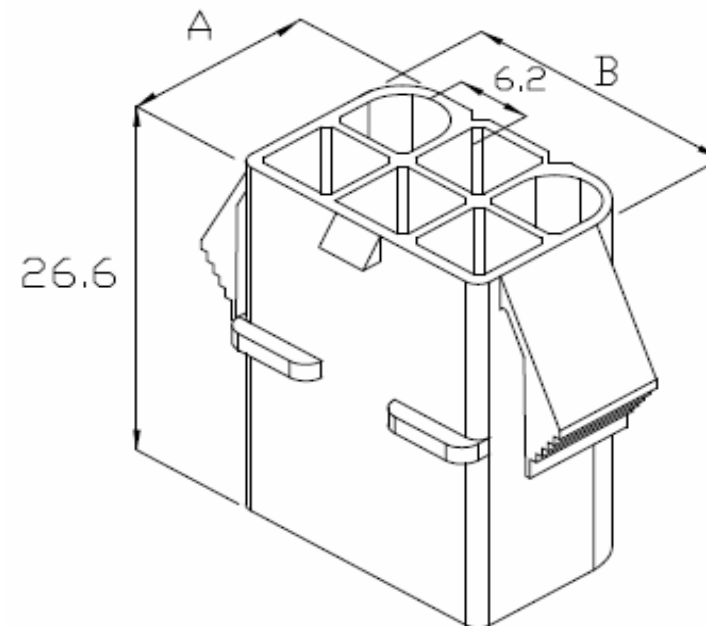
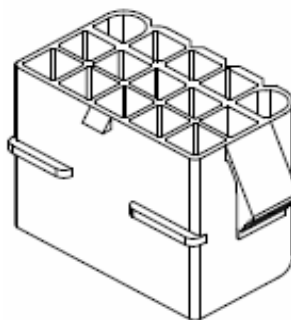

Item-No.		Dimension (mm)	
		A	B
T70R012	2Pos.	7,2	14,0
T70R013	3Pos.	7,2	20,3
T70R014	4Pos.	7,2	26,6
T70R015	2x2Pos.	13,4	33,0
T70R016	2x3Pos.	13,4	19,6
T70R017	2x4Pos.	19,6	19,6
T70R018	3x4Pos.	19,6	25,8
T70R019	3x5Pos.	19,6	32,0

**Wire to Wire Connector
Pitch 6,20mm**

Part No.: **T70R019**

DRW:	Jason	CHKD	Wilson	MATL:	Wilson	TOLERANCE	Mason	DATE	30.10.2010
APPD:	Schumi			FINISH	Jamy		Sheet No.		1 from 2

Customer:
email: info@edcon-components.com

EDCON-COMPONENTS

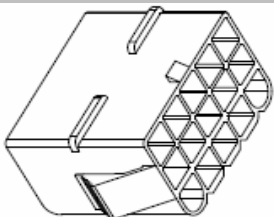

Ordering Informations

Serie	ROHS	Packing				
T70R019	R	BU				

R= ROHS Conform	BU= Bulk-Ware
N= NON ROHS Conform	

Wire to Wire Connector Pitch 6,20mm	
Part No.:	T70R019
Customer:	

DRW:	Jason	CHKD	Wilson	MATL:	Wilson	TOLERANCE	Mason	DATE	30.10.2010
APPD:	Schumi			FINISH	Jamy		Sheet No.		2 from 2