

# EDCON-COMPONENTS

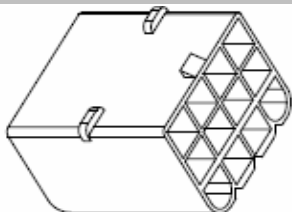

## Technical Discription

**Material:** Nylon 66 UL94 V-2  
**No. of Positions:** 3x4Pos.  
**Type of Housing:** Plug  
**Current Rating:** 2,5A AC/DC  
**Voltage Rating:** 250V AC/DC  
**Temperature Range:** -25°C ~ +85°C  
**Contact Resistance:** Initial Value/10mΩ max.  
**After environmental testing:** 20mΩ max.  
**Insulation Resistance:** 1000MΩ min.  
**Withstanding Voltage:** 1500V AC/minute  
**Applicable Wire:** AWG18~22

## Drawing

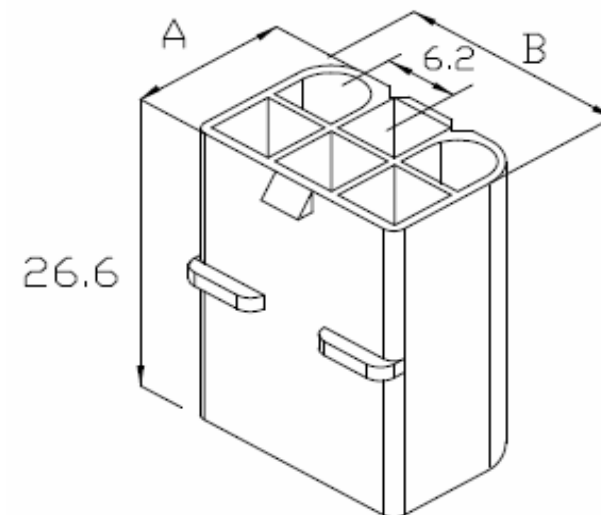
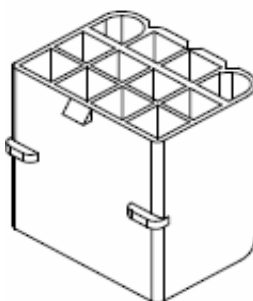

Item-No.		Dimension (mm)	
		A	B
T70R003	1Pos.	7,0	7,0
T70R004	2Pos.	7,2	14,0
T70R005	3Pos.	7,2	20,3
T70R006	4Pos.	7,2	26,6
T70R007	2x2Pos.	13,4	33,0
T70R008	2x3Pos.	13,4	19,6
T70R009	2x4Pos.	19,6	19,6
T70R010	3x4Pos.	19,6	25,8
T70R011	3x5Pos.	19,6	32,0

**Wire to Wire Connector  
Pitch 6,20mm**

Part No.: **T70R010**

DRW:	Jason	CHKD	Wilson	MATL:	Wilson	TOLERANCE	Mason	DATE	30.10.2010
APPD:	Schumi			FINISH	Jamy		Sheet No.		1 from 2

Customer:  
email: info@edcon-components.com

# EDCON-COMPONENTS

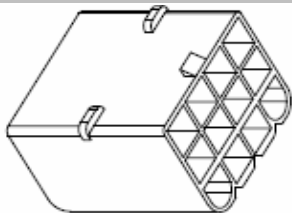

## Ordering Informations

Serie	ROHS	Packing				
-------	------	---------	--	--	--	--

T70R010	-	R	BU			
---------	---	---	----	--	--	--

R= ROHS Conform	BU= Bulk-Ware
N= NON ROHS Conform	

<b>Wire to Wire Connector Pitch 6,20mm</b>	
Part No.:	<b>T70R010</b>
Customer:	

DRW:	Jason	CHKD	Wilson	MATL:	Wilson	TOLERANCE	Mason	DATE	30.10.2010
APPD:	Schumi			FINISH	Jamy		Sheet No.		2 from 2