

EDCON-COMPONENTS

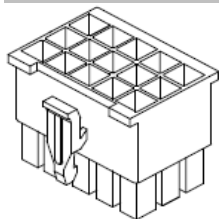

Technical Discription

Material: Nylon 66 UL94 V-2
 Mates with Terminal: T70L010 + T70L019
 No. of Positions: 3x5Pos.
 Type of Housing: Receptacle

Drawing

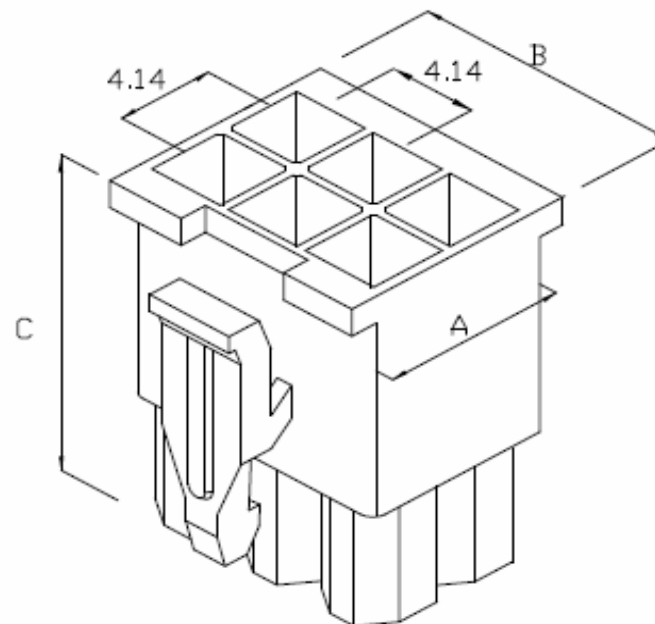

Item-No.		Dimension (mm)		
		A	B	C
T70L024	1Pos.	5,6	5,6	24,0
T70L025	2Pos.	9,8	5,6	24,0
T70L026	3Pos.	14,0	5,6	24,0
T70L027	2x2Pos	9,8	9,8	24,0
T70L028	2x3Pos	9,8	14,0	24,0
T70L029	3x3Pos.	14,0	14,0	24,0
T70L030	3x4Pos.	14,0	18,5	24,0
T70L031	3x5Pos.	14,0	23	24,0

Wire to Wire Connector	
Pitch 4,14mm	
Part No.:	T70L031
Customer:	

DRW:	Jason	CHKD	Wilson	MATL:	Wilson	TOLERANCE	Mason	DATE	30.10.2010
APPD:	Schumi			FINISH	Jamy		Sheet No.		1 from 2

EDCON-COMPONENTS

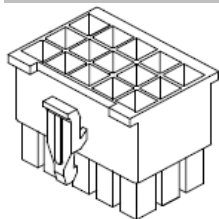

Ordering Informations

Serie	ROHS	Packing				
T70L031	R	BU				

R= ROHS Conform	BU= Bulk-Ware
N= NON ROHS Conform	

Wire to Wire Connector Pitch 4,14mm	
Part No.:	T70L031
Customer:	

DRW:	Jason	CHKD	Wilson	MATL:	Wilson	TOLERANCE	Mason	DATE	30.10.2010
APPD:	Schumi			FINISH	Jamy		Sheet No.		2 from 2