

EDCON-COMPONENTS

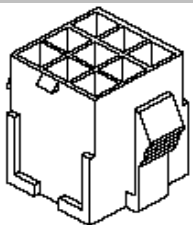

Technical Discription

Material: Nylon 66 UL94 V-2
 Mates with Terminal: T70L029
 No. of Positions: 3x3Pos.
 Type of Housing: Plug

Drawing

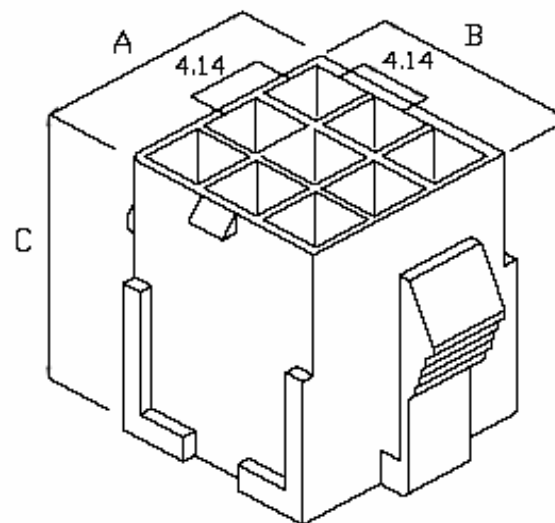

Item-No.		Dimension (mm)		
		A	B	C
T70L012	1Pos.	5,6	5,6	24,0
T70L013	2Pos.	9,8	5,6	24,0
T70L014	3Pos.	14,0	5,6	24,0
T70L015	2x2Pos	9,8	9,8	24,0
T70L016	2x3Pos	9,8	14,0	24,0
T70L017	3x3Pos.	14,0	14,0	24,0
T70L018	3x4Pos.	14,0	18,5	24,0
T70L019	3x5Pos.	14,0	22,5	24,0

**Wire to Wire Connector
Pitch 4,14mm**

Part No.: **T70L017**

DRW:	Jason	CHKD	Wilson	MATL:	Wilson	TOLERANCE	Mason	DATE	30.10.2010
APPD:	Schumi			FINISH	Jamy		Sheet No.	1 from 2	

Customer:
email: info@edcon-components.com

EDCON-COMPONENTS

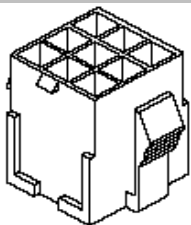

Ordering Informations

Serie	ROHS	Packing				
T70L017	R	BU				

R= ROHS Conform	BU= Bulk-Ware
N= NON ROHS Conform	

Wire to Wire Connector Pitch 4,14mm	
Part No.:	T70L017
Customer:	

DRW:	Jason	CHKD	Wilson	MATL:	Wilson	TOLERANCE	Mason	DATE	30.10.2010
APPD:	Schumi			FINISH	Jamy		Sheet No.		2 from 2