

EDCON-COMPONENTS

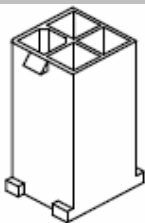

Technical Discription

Material: Nylon 66 UL94 V-2
 Mates with Terminal: T70L027
 No. of Positions: 2x2
 Type of Housing: Plug

Drawing

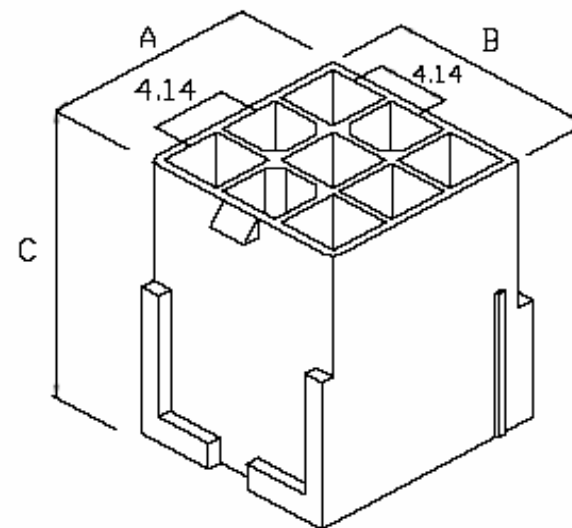

| Item-No. | | Dimension (mm) | | |
|----------|---------|----------------|------|------|
| | | A | B | C |
| T70L003 | 1Pos. | 5,6 | 5,6 | 24,0 |
| T70L004 | 2Pos. | 9,8 | 5,6 | 24,0 |
| T70L005 | 3Pos. | 14,0 | 5,6 | 24,0 |
| T70L006 | 2x2Pos. | 9,8 | 9,8 | 24,0 |
| T70L007 | 2x3Pos. | 9,8 | 14,0 | 24,0 |
| T70L008 | 3x3Pos. | 14,0 | 14,0 | 24,0 |
| T70L009 | 3x4Pos. | 14,0 | 18,5 | 24,0 |
| T70L010 | 3x5Pos. | 14,0 | 22,5 | 24,0 |

**Wire to Wire Connector
Pitch 4,14mm**

Part No.: **T70L006**

| | | | | | | | | | |
|-------|--------|------|--------|--------|--------|-----------|-----------|------|------------|
| DRW: | Jason | CHKD | Wilson | MATL: | Wilson | TOLERANCE | Mason | DATE | 30.10.2010 |
| APPD: | Schumi | | | FINISH | Jamy | | Sheet No. | | 1 from 2 |

Customer:
email: info@edcon-components.com

EDCON-COMPONENTS

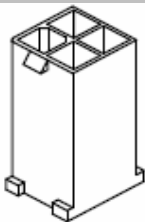

Ordering Informations

| Serie | ROHS | Packing | | | | |
|---------|------|---------|--|--|--|--|
| T70L006 | R | BU | | | | |

| | |
|---------------------|---------------|
| R= ROHS Conform | BU= Bulk-Ware |
| N= NON ROHS Conform | |

| | |
|--|----------------|
| Wire to Wire Connector Pitch 4,14mm | |
| Part No.: | T70L006 |
| Customer: | |

| | | | | | | | | | |
|-------|--------|------|--------|--------|--------|-----------|-----------|------|------------|
| DRW: | Jason | CHKD | Wilson | MATL: | Wilson | TOLERANCE | Mason | DATE | 30.10.2010 |
| APPD: | Schumi | | | FINISH | Jamy | | Sheet No. | | 2 from 2 |