

EDCON-COMPONENTS

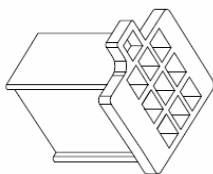

Technical Discription

Material: Nylon 66 UL94V-2
 Number of Position: 3x3Pos.
 K-Type

Current Rating: 3A AC/DC
 Voltage Rating: 250 VAC/DC
 Temperature Range: -25°C ~ +85°C
 Contact Resistance: Initial Value / 10mΩ max.
 After environmental Testing: 20mΩ max.
 Insulation Resistance: 500MΩ min.
 Withstanding Voltage: 1000VAC / minute

Item-No.		Dimension (mm)		
		A	B	C
T70K036	1x2Pos.	6,2	19,5	10,4
T70K037	1x3Pos.	6,2	19,5	14,4
T70K038	2x2Pos.	11,2	19,5	10,4
T70K039	2x3Pos.	11,2	19,5	14,4
T70K040	3x3Pos.	16,2	19,5	14,4

Drawing

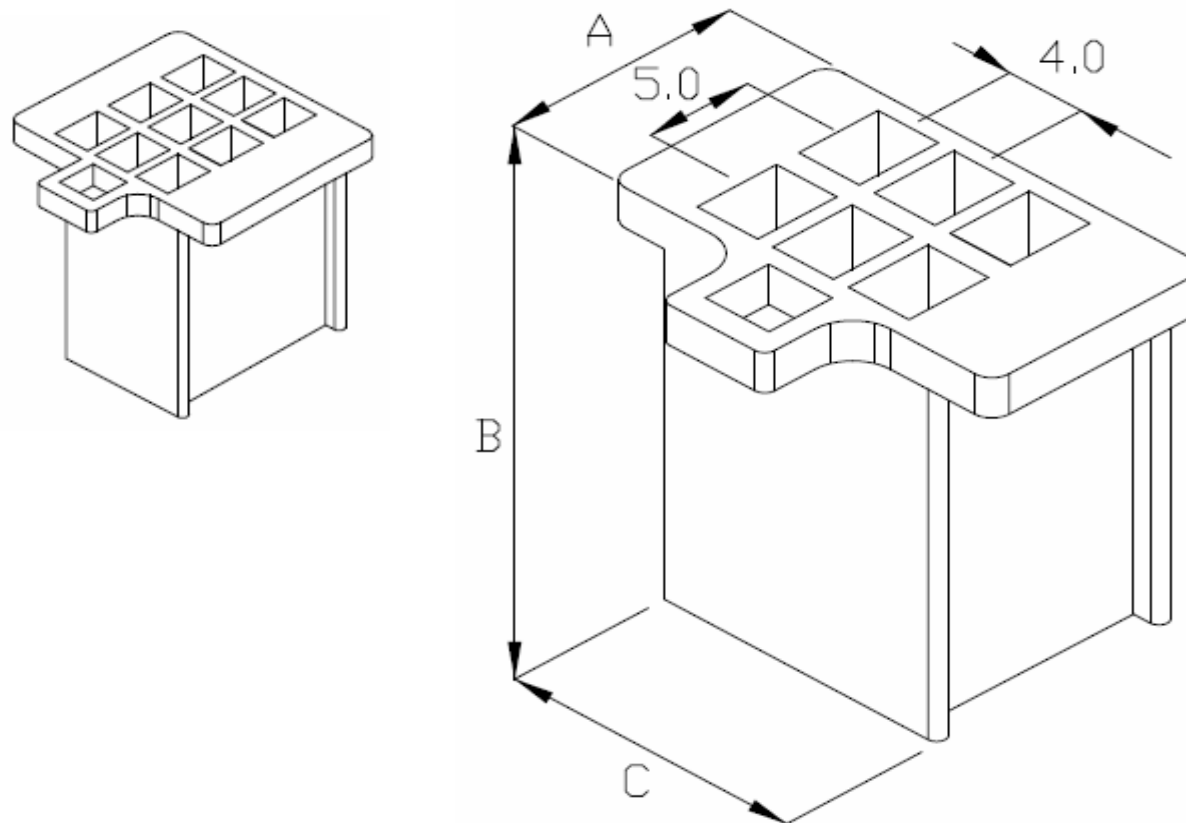

Wire to Wire Connector	
Pitch 4,00mm	
Part No.:	T70K040
Customer:	

DRW:	Jason	CHKD	Wilson	MATL:	Wilson	TOLERANCE	Mason	DATE	30.10.2010
APPD:	Schumi			FINISH	Jamy		Sheet No.		1 from 2

EDCON-COMPONENTS

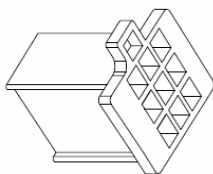

Ordering Informations

Serie	ROHS	Packing				
T70K040	R	BU				

R= ROHS Conform	BU= Bulk-Ware
N= NON ROHS Conform	

Wire to Wire Connector Pitch 4,00mm	
Part No.:	T70K040
Customer:	

DRW:	Jason	CHKD	Wilson	MATL:	Wilson	TOLERANCE	Mason	DATE	30.10.2010
APPD:	Schumi			FINISH	Jamy		Sheet No.		2 from 2