

EDCON-COMPONENTS

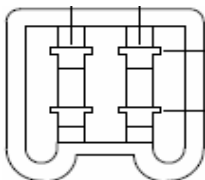

Technical Discription

Material: Nylon 66 UL94V-2
 Number of Position: 2x2Pos.

Current Rating: 3A AC/DC
 Voltage Rating: 250 VAC/DC
 Temperature Range: -25°C ~ +85°C
 Contact Resistance: Initial Value / 10mΩ max.
 After environmental Testing: 20mΩ max.
 Insulation Resistance: 500MΩ min.
 Withstanding Voltage: 1000VAC / minute

Drawing

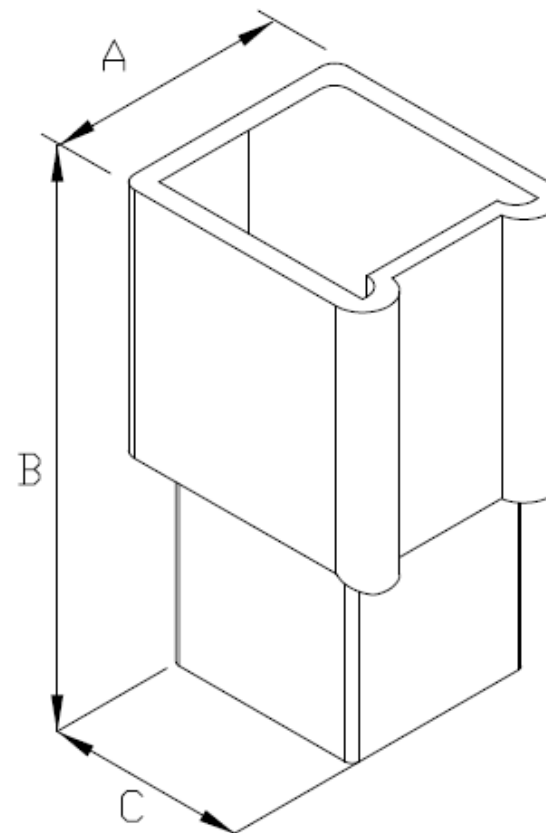
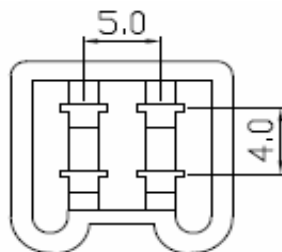

Item-No.		Dimension (mm)		
		A	B	C
T70K030	1x3Pos.	9,5	32,0	13,2
T70K031	2x2Pos.	14,5	32,0	9,4
T70K032	2x3Pos.	14,5	32,0	13,2
T70K033	3x3Pos.	19,4	32,0	13,2

Wire to Wire Connector	
Pitch 4,00mm	
Part No.:	T70K031
Customer:	

DRW:	Jason	CHKD	Wilson	MATL:	Wilson	TOLERANCE	Mason	DATE	30.10.2010
APPD:	Schumi			FINISH	Jamy		Sheet No.		1 from 2

EDCON-COMPONENTS

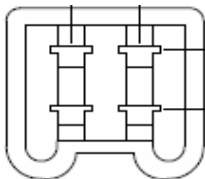

Ordering Informations

Serie	ROHS	Packing				
T70K031	R	BU				

R= ROHS Conform	BU= Bulk-Ware
N= NON ROHS Conform	

Wire to Wire Connector Pitch 4,00mm	
Part No.:	T70K031
Customer:	

DRW:	Jason	CHKD	Wilson	MATL:	Wilson	TOLERANCE	Mason	DATE	30.10.2010
APPD:	Schumi			FINISH	Jamy		Sheet No.		2 from 2