

EDCON-COMPONENTS



Discription Housing Type 1

Material: Nylon
 Mates: with Terminal R55001
 Rating Voltage: AC/250, DC350V
 Rating Current: 10A
 Temperature Range: . 25°C ~ +85°C

Drawing (mm)

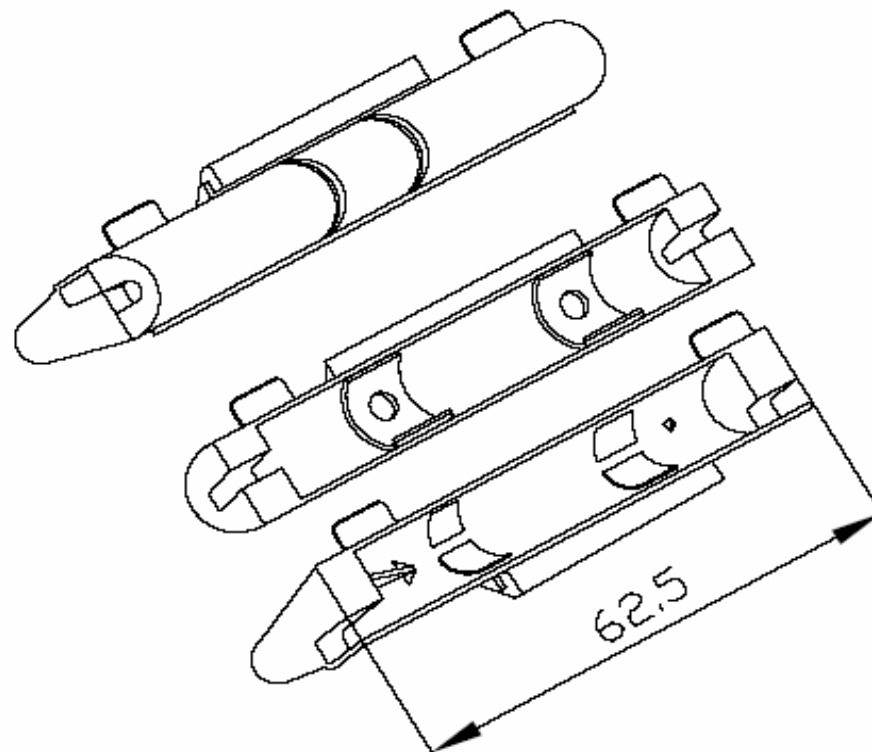

**Axial Fuse Housing for
5x20mm Fuse**

Part No.:

Customer:

DRW:	Jason	CHKD	Wilson	MATL:	Wilson	TOLERANCE	Mason	DATE	30.10.2010
APPD:	Schumi			FINISH	Jamy		Sheet No.		1 from 2

EDCON-COMPONENTS



Ordering Informations

Terminal

Serie	ROHS	Packing				
R55004	R	BU				

R= ROHS Conform	BU= Bulk-Ware
N= NON ROHS Conform	

Axial Fuse Housing for 5x20mm Fuse	
Part No.:	R55004
Customer:	

DRW:	Jason	CHKD	Wilson	MATL:	Wilson	TOLERANCE	Mason	DATE	30.10.2010
APPD:	Schumi			FINISH	Jamy		Sheet No.	2 from 2	