



# DATA SHEET

## Y2 AC Ceramic Capacitor 250VAC

### Serie: I22003

Mat. Code	<b>B</b>	Material: <b>B= Y5P</b>
Voltage Code	<b>251</b>	Voltage: <b>251= 250VAC</b>
Range Code	<b>561</b>	Range: <b>561= 560pf</b>

**Y2 AC Ceramic Capacitor  
250VAC**

Serie No.: **I22003**

Customer:

DRW:	Jason	CHKD	Wilson	MATL:	Wilson	TOLERANCE	Mason	DATE	01.11.2010
APPD:	Schumi			FINISH	Jamy		Sheet No.		1 from 13

# EDCON-COMPONENTS



## Technical Specifications

Temperature Characteristics	Y5P and Y5U and Y5V
Capacitance Change of Temperature Coefficient	Y5P = $\pm 10\%$
	Y5U = $\pm 20\% \sim -55\%$
	Y5V = $\pm 30\% \sim -80\%$
Temperature Range:	-25°C ~ +85°C
Capacitance Tolerance:	K = $\pm 10\%$
	M = $\pm 20\%$

## Nominal Capacitance Code (Example)

Code	Capacitance (pf)
101	100
102	1000
222	2200
103	10000

Nominal capacitance shall consist of three numbers in the unit of picofard(pf). The first and the second numbers mean the significant figures and the third number shall present the number of zeros following the significant figures.

## Lead Style Informations

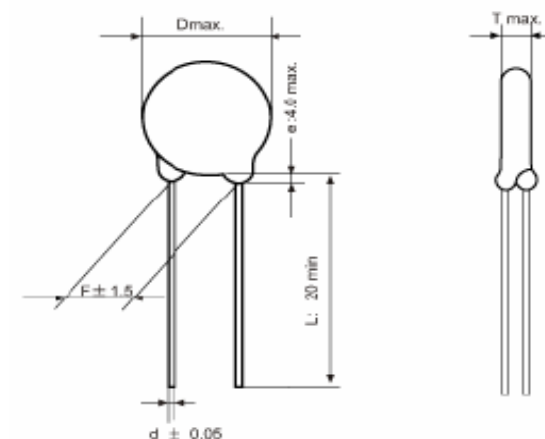

## Lead Code Style (A) (mm)

Pitch Code	A	B	C	D	E
F	2,5	5,0	7,5	10	12,5
L	only 20mm long lead				
d	0,5 or 0,6 or 0,8mm				
e	max. 4,0mm				

**Y2 AC Ceramic Capacitor  
250VAC**

Part No.: **I22003**

DRW:	Jason	CHKD	Wilson	MATL:	Wilson	TOLERANCE	Mason	DATE	01.11.2010
APPD:	Schumi			FINISH	Jamy		Sheet No.		2 from 13

Customer:  
email: info@edcon-components.com

# EDCON-COMPONENTS



## Lead Style Informations

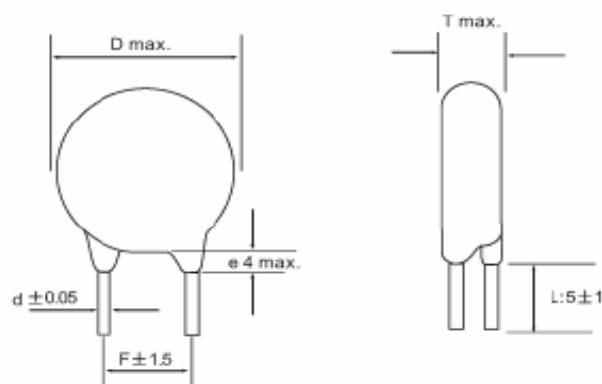

## Lead Style Informations

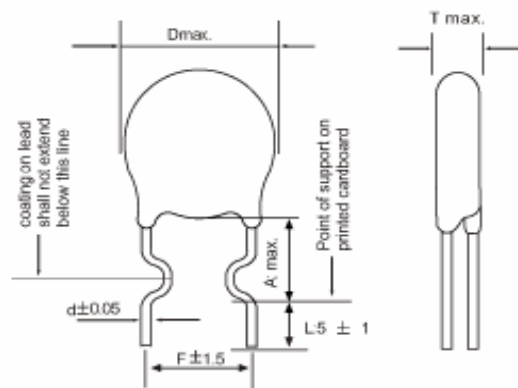

## Lead Style Informations



### Lead Code Style (B) Unit (mm)

Pitch Code	A	B	C	D	E
F	2,5	5,0	7,5	10	12,5
L	5,0mm or on customer request				
d	0,5 or 0,6 or 0,8mm				
e	max. 4,0mm				

### Lead Code Style (C) Unit (mm)

Pitch Code	B	C	D	E
F	5,0	7,5	10	12,5
A	5,0	5,0	6,5	6,5
L	5,0mm or on customer request			
d	0,5 or 0,6 or 0,8mm			

### Lead Code Style (D) Unit (mm)

Pitch Code	B	C	D	E
F	5,0	7,5	10	12,5
A	5,0	5,0	6,5	6,5
L	20mm min.			
d	0,5 or 0,6 or 0,8mm			

### Y2 AC Ceramic Capacitor 250VAC

Part No.: **I22003**

DRW:	Jason	CHKD	Wilson	MATL:	Wilson	TOLERANCE	Mason	DATE	01.11.2010
APPD:	Schumi			FINISH	Jamy		Sheet No.		3 from 13

Customer:  
email: [info@edcon-components.com](mailto:info@edcon-components.com)

[www.edcon-components.com](http://www.edcon-components.com)

# EDCON-COMPONENTS



## Lead Style Informations

## Lead Style Informations

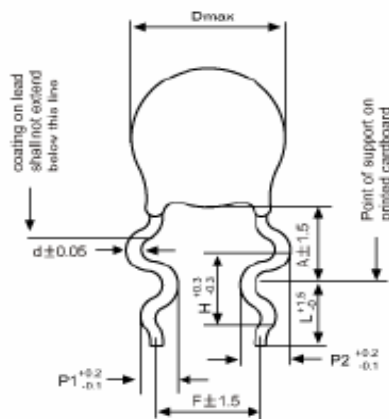
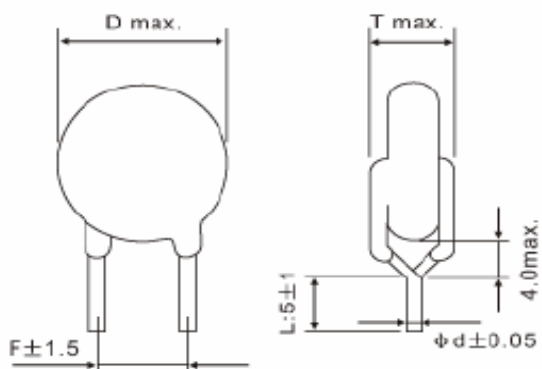

### Lead Code Style (H) Unit (mm)

### Lead Code Style (M) Unit (mm)

Pitch Code	B	C	D	E
F	5,0	7,5	10	12,5
L	5,0mm or on customer request			
d	0,5 or 0,6 or 0,8mm			

Pitch Code	B	C	D	E
F	5,0	7,5	10	12,5
H	2,6	2,6	3,3	3,3
P1	1,3	1,25	1,65	1,65
P2	1,65	1,65	1,95	1,95
A	D<8: 6,0± 1,5, D>8: 7,0± 1,5			
L	3,0 ~ 30mm			
d	0,5 or 0,6 or 0,8mm			

**Y2 AC Ceramic Capacitor  
250VAC**

Part No.: **I22003**

DRW:	Jason	CHKD	Wilson	MATL:	Wilson	TOLERANCE	Mason	DATE	01.11.2010
APPD:	Schumi			FINISH	Jamy		Sheet No.		4 from 13

Customer:  
email: info@edcon-components.com

[www.edcon-components.com](http://www.edcon-components.com)

# EDCON-COMPONENTS



## Specification and test method

Operating Temperature range -25°C ~ +105°C  
 But temperature range is -25% ~ +85°C at safety standard specification.

Test and measurement shall be made at the standard condition.  
 ( Temperature 15 ~ 35°C relative humidity 45 ~ 75% and atmospheric pressure 860~1060hpa). Unless otherwise specified herein it doubt accurated on the value of measurement, and remesurement was requested by customer capacitor shall be measured at the reference condition ( Temperature 20 ±2°C, relative humidity 60~70% and atmospheric pressure 860~1060hpa). unless otherwise specified herein.

## Leakage Current Characteristics

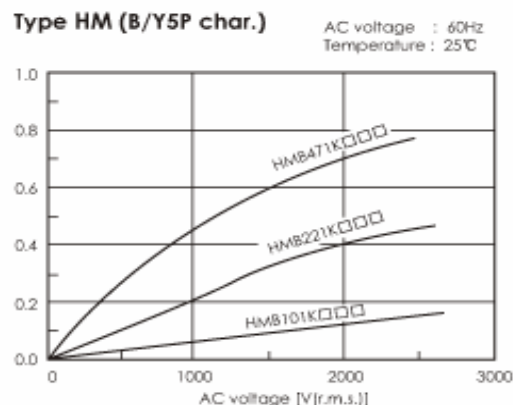

## Capacitance Temperature Characteristics

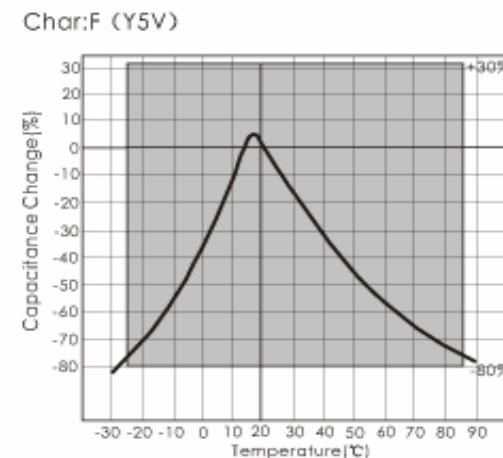

## Impedance vs. Frequency Characteristics

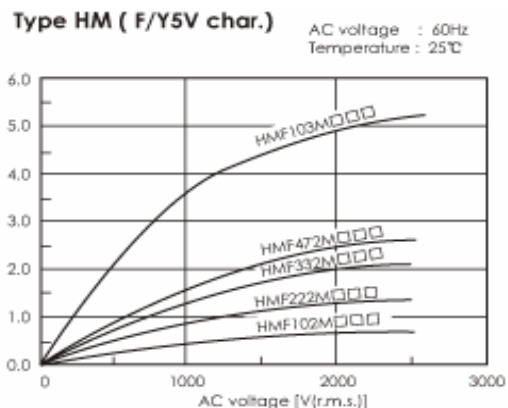
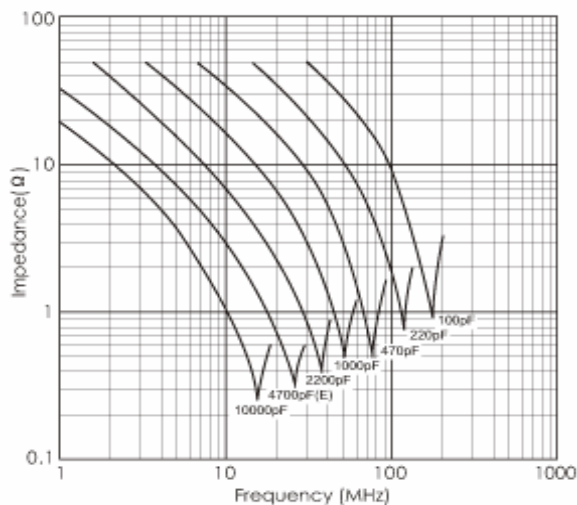

## Char: B (Y5P)

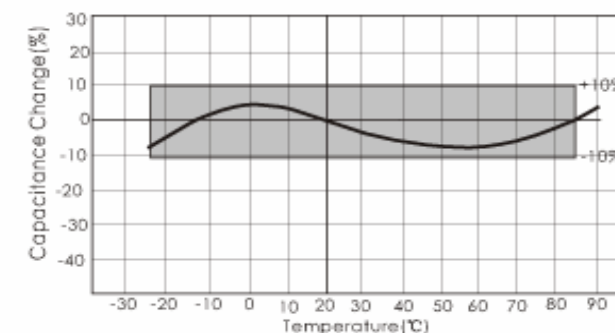

**Y2 AC Ceramic Capacitor  
250VAC**

Part No.: **I22003**

Customer:

DRW:	Jason	CHKD	Wilson	MATL:	Wilson	TOLERANCE	Mason	DATE	01.11.2010
APPD:	Schumi			FINISH	Jamy		Sheet No.	5 from 13	

# EDCON-COMPONENTS

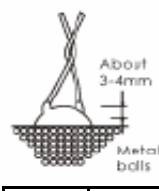

Item	Specification	Testing Method
Appearance and Dimensions	No marked defect on appearance from and dimension are within specified range.	The capacitor shall be inspected by naked eyes for visible evidence of defect. Dimensions shall be measured with slide calipers.
Marking	To be easily legible.	The capacitor shall be inspected by naked eyes
Capacitance	Within specified tolerance	The capacitance, dissipation shall be measured at $25 \pm 2^\circ\text{C}$ with $1 \pm 0,1\text{KHz}$ and $AC1 \pm 0,1\text{V}$ (r.m.s)
Dissipation Factor (D,F)	Char. Specification B, E= D,F= $\leq 2,5\%$	
	F= D,F= $\leq 5,0\%$	
Insulation Resistance (R)	10000M $\Omega$ min.	The insulation resistance shall be measured with DC $500 \pm 50\text{V}$ within $60 \pm 5\text{sec}$ . Of charging.
Dielectric Strength	Between Lead wires	No failure The capacitor shall not be damage when AC 2600V (r.m.s.) are applied between the lead wires for 60s.
	Body Insulation	No failure First, the terminals of the capacitor shall be connected together. Then as shown in Figure right, a metal foil shall be closely wrapped around the body of the capacitor to the distance of about 3-4mm from each terminal. Then the capacitor shall be inserted into a container filled with balls of about 1mm diameter. Finally AC 2600V (r.m.s.) is applied for 60s between the capacitor lead wires and metal balls. 

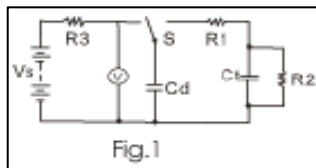
Item	Specification	Testing Method		
Temperature Characteristics	Char. Capacitance Change	The capacitance measurement shall be made of each step specified in table 3.		
	B	within $\pm 10\%$	Step	Temperature ( $^\circ\text{C}$ )
	E	within $+ 20\% -55\%$	1	$+ 20 \pm 2$
	F	within $+ 30\% -80\%$	2	$- 25 \pm 2$
	Temperature characteristics guarantee is $-25$ to $+85^\circ\text{C}$		3	$+ 20 \pm 2$
		4	$+ 85 \pm 2$	
		5	$+ 20 \pm 2$	
Discharge test (1)	Appearance	No marked defect.	As in figure , discharge in made 50 times at 5sec intervals from the capacitor (Cd) charged at DC voltage of specified  Fig.1	
	I.R.	1000M $\Omega$ min.		
	Dielectric Strength	per Item 6.		

**Y2 AC Ceramic Capacitor  
250VAC**

Part No.: **I22003**

Customer:

DRW:	Jason	CHKD	Wilson	MATL:	Wilson	TOLERANCE	Mason	DATE	01.11.2010
APPD:	Schumi			FINISH	Jamy		Sheet No.		6 from 13

# EDCON-COMPONENTS



Item	Specification	Testing Method	Item	Specification	Testing Method						
Discharge Trest II	The cheese-cloth around capacitors shall not glow or flame.	<p>A single layer of cheese cloth is to be placed around the body of the test capacitor. Each sample is to be subjected to four discharges from a dump capacitor charged to a voltage that. When discharged, placed DC 5KV across the capacitor under test. The interval between successive discharge is to be 5s. AC240V (r.m.s.)-60Hz potential is to applied across the capacitor under test and is to be maintained for 30s. after the fourth discharge, unless the circuit is opened in a shorter time by breakdown of the capacitor. The direct current supply is to be adjusted to provide a potential in accordance with the following.</p> <div style="text-align: center;"> <math display="block">V_{dc} = \frac{5000(C_d + C_t)}{C_d} (V)</math> <p style="text-align: center;">Fig.2</p> </div> <p>Vdc: Variable direct-current voltage source.</p> <p>s: High voltage switch</p> <p>L: Choke coil of appr. 3mH and 0,03Ω</p> <p>F: Plug fuse rated 30A and 250V</p> <p>Vac.: supply source rated 240V 60Hz 30A</p> <p>C1: Capacitor under test.</p> <p>Cd: Dump Capacitor</p>	Discharge Trest II	The cheese-cloth around capacitors shall not glow or flame.	Capacitance value and D.F. are follows. Cap. Value Cd to 0,005μF 0,0051 to 0,05μF Cap. Value CD 0,005μF 0,05μF D.F of Cd. 0,5% max. 0,5%max.						
			Solderability of leads	Lead wire shall be soldered with uniformly coated on the axial direction over 3/4 of the circumferential direction.	The lead wire of capacitor shall be dipped into molten solder of 235 ± 5°C for 2 ± 0,5s. The depth of immersion is up to about 1,5 to 2,0mm from the root of lead wires.						
Vibration Resistance	Apperance	No market defect Within the specified tolerance	D, F.	Char. B, E F	Specification D,F, ≤ 2,5% D,F, ≤ 5,0%						
	Capacitance										
<table border="1" style="margin-left: auto; margin-right: 0;"> <tr> <td colspan="2" style="text-align: center;"><b>Y2 AC Ceramic Capacitor</b></td> </tr> <tr> <td colspan="2" style="text-align: center;"><b>250VAC</b></td> </tr> <tr> <td>Part No.:</td> <td style="text-align: right;"><b>I22003</b></td> </tr> </table>						<b>Y2 AC Ceramic Capacitor</b>		<b>250VAC</b>		Part No.:	<b>I22003</b>
<b>Y2 AC Ceramic Capacitor</b>											
<b>250VAC</b>											
Part No.:	<b>I22003</b>										
DRW:	Jason	CHKD	Wilson	MATL:	Wilson	TOLERANCE	Mason	DATE	01.11.2010	Customer:	
APPD:	Schumi			FINISH	Jamy			Sheet No.	7 from 13		



# EDCON-COMPONENTS

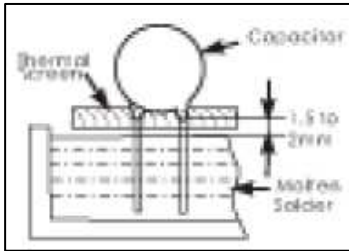

Item		Specification	Testing Method
Soldering Effect	Appearance	No marked defect	As in figure, the lead wires shall be immersed solder of $350 \pm 10^\circ\text{C}$ or $260 \pm 5^\circ\text{C}$ up to 1,5 ~ 2,0mm from the root of the terminal for $3,5 \pm 0,5\text{s}$ . ( $10 \pm 1\text{s}$ for $260 \pm 5^\circ\text{C}$ ).
	Capacitance change	Within $\pm 10\%$	
	I.R.	1000M $\Omega$ min.	
	Dielectric Strength	Pre Item 6.	 <p>Pre-treatment: Capacitor shall be stored at <math>85 \pm 2^\circ\text{C}</math> for 1h. Then placed at room conditions for <math>24 \pm 2\text{h}</math> before initial measurements.</p> <p>Post-treatment: Capacitor shall be stored for 1 to 2 h at room conditions.</p>

Item		Specification	Testing Method	
Humidity ( Under Steady State)	Appearance	No marked defect.	Set the capacitor for $500 \pm 12\text{h}$ at $40 \pm 2^\circ\text{C}$ in 90 ~ 95% relative humidity. Post-treatment: Capacitor shall be stored for 1 to 2h at room condition.	
	Capacitance Change	Char. Capacitance Change		
		B		within $\pm 10\%$
	D,F,	E,F		within $\pm 15\%$
		Char. Specification		
		B,E		D.F. $\leq 5,0\%$
	I.R.	F		D.F. $\leq 7,5\%$
3000M $\Omega$ min.				
Dielectric Strength	Per Item 6			
Humidity Loading	Appearance	No marked defect.		Apply the rated voltage for $500 \pm 12\text{h}$ at $40 \pm 2^\circ\text{C}$ in 90 ~ 95% relative humidity. Post-treatment: Capacitor shall be stored for 1 to 2h at room condition.
	Capacitance Change	Char. Capacitance Change		
		B	within $\pm 10\%$	
	D,F,	E,F	within $\pm 15\%$	
		Char. Specification		
		B,E	D.F. $\leq 5,0\%$	
	I.R.	F	D.F. $\leq 7,5\%$	
3000M $\Omega$ min.				
Dielectric Strength	Per Item 6			

**Y2 AC Ceramic Capacitor  
250VAC**

Part No.: **I22003**

DRW:	Jason	CHKD	Wilson	MATL:	Wilson	TOLERANCE	Mason	DATE	01.11.2010
APPD:	Schumi			FINISH	Jamy		Sheet No.	8 from 13	Customer:



# EDCON-COMPONENTS



Item	Specification	Testing Method
Life	Appearance	No marked defect.
	Capacitance Change	Within $\pm 20\%$
	I.R.	3000M $\Omega$ min.
	Dielectric Strength	Per Item 6.
Discharge Test (II)	Per Item 9.	<p>Impulse Voltage</p> <p>Each individual Capacity shall be subjected to 5KV impulses for three times. After the capacitance are supplied to life test.</p> <p><math>T1 = 1.2 \mu s = 1.671</math> <math>T2 = 50 \mu s</math></p> <p>Apply a voltage of table 4 for 1000h at 105 <math>\pm 2/0^\circ C</math>, and relative humidity of 50% max. (table 4)</p> <p>Applied Voltage</p> <p>AC 425V (r.m.s.). Except that once each hour the voltage is increased to AC 1000V (r.m.s.) for 0,1s.</p> <p>Post-treatment: Capacitor shall be stored for 1 to 2h at room temperature.</p>

Item	Specification	Testing Method	
Flame Test	The capacitor flame discontinues as follows.	<p>The Capacitor shall be subjected to applied flame for 15s and then removed for 15 s until 5 cycle.</p> <p>Gas Burner (in mm)</p>	
	Cycle		Time
	1 to 4		30s max.
5	60s. Max		
Robustness of Termination	<p>Tensile</p> <p>Bending</p>	<p>Lead wire shall not cut off. Capacitor shall not be broken.</p>	
Active Flammability	The chees-cloth shall not be on fire.	<p>Each lead wire shall be subjected to 5N weight and then a 90° bend, at the point of egress, in one direction, return to original position, and then a 90° bend in the opposite direction at the rate of one bend in 2 to 3s.</p>	

**Y2 AC Ceramic Capacitor  
250VAC**

Part No.: **I22003**

DRW:	Jason	CHKD	Wilson	MATL:	Wilson	TOLERANCE	Mason	DATE	01.11.2010	Customer:
APPD:	Schumi			FINISH	Jamy		Sheet No.	9 from 13		

# EDCON-COMPONENTS

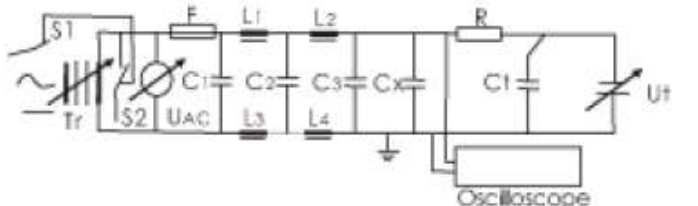
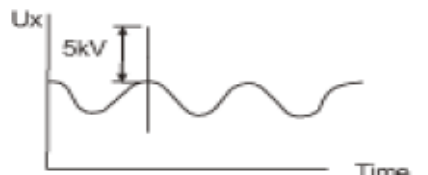
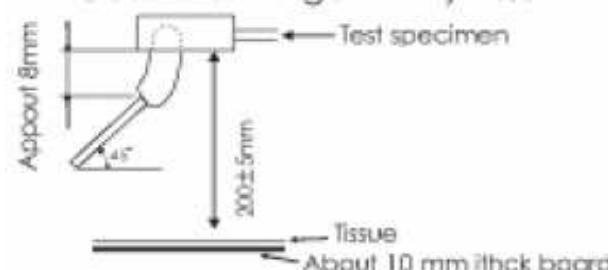

Item	Specification	Testing Method	Item	Specification	Testing Method					
Active Flammability	The cheese-cloth shall not be on fire.	The capacitor shall be individually wrapped in at least one but more than two complete layers of cheese-cloth. The capacitor shall be subjected to 20 discharges. The interval between successive discharges shall be 5s. The UAC shall be maintained for 2min after the last discharge.	Passive Flammability	The burning time shall not be exceeded the time 30s. The tissue paper shall not ignite.	The capacitor under test shall be held in the flame in the position which best promotes burning. Each specimen shall only be exposed once to the flame. Time of exposure to flame: 30s.  Length of flame: 12± 1mm. Gas burner: Length 35mm min. Inside Dia: 0,5 ± 0,1mm- Outside Dia. 0,9mm max. Gas: Butane gas Purity 95% min.					
	The cheese-cloth shall not be on fire	<p>C1,2: 1µF ±10%</p> <p>C3: 0,033µ ± 5% 10KV</p> <p>Ct: 3µF ± 5% 10KV</p> <p>Cx: Capacitor under test</p> <p>F: Fuse rated 10A</p> <p>L1 to 4: 1,5mH ± 20%</p> <p>16A Rod core choke</p> <p>R: 100Ω ±2%</p> <p>UAC: UR ±5%</p> <p>UR: Rated Voltage</p> <p>Ut: Voltage applied to Ct</p>  								
DRW:	Jason	CHKD	Wilson	MATL:	Wilson	TOLERANCE	Mason	DATE	01.11.2010	Customer:
APPD:	Schumi			FINISH	Jamy			Sheet No.	10 from 13	

**Y2 AC Ceramic Capacitor  
250VAC**

Part No.: **I22003**

# EDCON-COMPONENTS



Item		Specification		Testing Method							
Temperature and Immersion Style	Appearance	No marked defect		The capacitor shall be subjected to 5 temperature cycles, then consecutively to 2 immersion cycles.							
	Capacitance Change	Char.	Capaci.Change					Temperature cycle			
		B	Within ± 10%								
		E;F	Within ± 20%	Step	Temperature (°C)	Time					
	D.F.			1	. -25 +0/-3	30min					
		Char.	Specification	2	Room temperature	3min					
		B;E	D.F. ≤ 5,0%	3	. + 105 +3/0	30min					
		F	D.F. ≤ 7,5%	4	Room temperature	3min					
				Cycle time: 5cycle Immersion cycle							
	I.R.	3000M Ω min.		Step	Temperature (°C)	Time	Immersion Water				
Dielectric Strength	Per Item 6		1	. +65 +/-0	15min	Clean Water					
			2	Room Temp.	15min.	Salt Water					
			Pre-treatment: Capacitor shall be stored at 85 ±2°C for 1h, then placed at room conditions for 24 ± 2h.								
Post-treatment: Capacitor shall be stored for 24 ± 2h at room conditions.											

"Room Condition" Temperature 15 to 35°C, Relative humidity: 45 to 75%, Atmospheric pressure: 6 to 106KPa.

**Y2 AC Ceramic Capacitor  
250VAC**

Part No.: **I22003**

DRW:	Jason	CHKD	Wilson	MATL:	Wilson	TOLERANCE	Mason	DATE	01.11.2010	Customer:
APPD:	Schumi			FINISH	Jamy		Sheet No.	11 from 13		

[www.edcon-components.com](http://www.edcon-components.com)

email: [info@edcon-components.com](mailto:info@edcon-components.com)

# EDCON-COMPONENTS



## Ordering Informations

Serie	Range	Temperature Character.	Voltage	Tolerance Code	Lead Style Code	Lead Length Code	Lead Space Code	ROHS	Packing Code	
-------	-------	------------------------	---------	----------------	-----------------	------------------	-----------------	------	--------------	--

<b>I22003</b>	<b>561</b>	<b>B</b>	<b>251</b>	<b>K</b>	<b>A</b>	<b>20</b>	<b>D</b>	<b>R</b>	<b>BU</b>	
---------------	------------	----------	------------	----------	----------	-----------	----------	----------	-----------	--

<b>561= 560pf</b>	<b>B= Y5P</b>	<b>251= 250VAC</b>	<b>K= 10%</b>	<b>A= Style A</b>	<b>20= 20mm</b>	<b>A= 2,50mm</b>	<b>R= ROHS Conform</b>	<b>BU= Bulk Ware</b>
				<b>B= Style B</b>	<b>05= 5mm / ±1mm</b>	<b>B= 5,00mm</b>	<b>N= NON ROHS Conform</b>	<b>TA= Tape Ammo Pack</b>
				<b>C= Style C</b>		<b>C= 7,50mm</b>		<b>TR= Tape Reel</b>
				<b>D= Style D</b>		<b>D= 10,0mm</b>		
				<b>H= Style H</b>		<b>E= 12,5mm</b>		
				<b>M= Style M</b>				

**Y2 AC Ceramic Capacitor  
250VAC**

Part No.: **I22003**

DRW:	Jason	CHKD	Wilson	MATL:	Wilson	TOLERANCE	Mason	DATE	01.11.2010
APPD:	Schumi			FINISH	Jamy		Sheet No.		12 from 13

Customer:



Soldering Profile Curve

Classification Reflow Profile (JEDEC J-STD-020C)



**Y2 AC Ceramic Capacitor  
250VAC**

Part No.: **I22003**

DRW:	Jason	CHKD	Wilson	MATL:	Wilson	TOLERANCE	Mason	DATE	01.11.2010
APPD:	Schumi			FINISH	Jamy		Sheet No.	13 from 13	Customer: