



# DATA SHEET

## Y1 AC Ceramic Capacitor 400VAC

### Serie: I22002

|              |            |                             |
|--------------|------------|-----------------------------|
| Mat. Code    | <b>E</b>   | Material: <b>B= Y5P</b>     |
| Voltage Code | <b>401</b> | Voltage: <b>401= 400VAC</b> |
| Range Code   | <b>222</b> | Range: <b>222= 2200pf</b>   |

**Y1 AC Ceramic Capacitor  
400VAC**

Serie No.: **I22002**

Customer:

|       |        |      |        |        |        |           |           |      |            |
|-------|--------|------|--------|--------|--------|-----------|-----------|------|------------|
| DRW:  | Jason  | CHKD | Wilson | MATL:  | Wilson | TOLERANCE | Mason     | DATE | 01.11.2010 |
| APPD: | Schumi |      |        | FINISH | Jamy   |           | Sheet No. |      | 1 from 13  |

# EDCON-COMPONENTS



## Technical Specifications

Temperature Characteristics Y5P and Y5U  
 Capacitance Change of Temperature Y5P =  $\pm 10\%$   
 Coefficient Y5U =  $\pm 20\% \sim -55\%$   
 Temperature Range:  $-25^{\circ}\text{C} \sim +85^{\circ}\text{C}$

Capacitance Tolerance: K =  $\pm 10\%$   
 M =  $\pm 20\%$

## Nominal Capacitance Code (Example)

| Code | Capacitance (pf) |
|------|------------------|
| 101  | 100              |
| 102  | 1000             |
| 222  | 2200             |
| 103  | 10000            |

Nominal capacitance shall consist of three numbers in the unit of picofard(pf). The first and the second numbers mean the significant figures and the third number shall present the number of zeros following the significant figures.

## Lead Style Informations



## Lead Code Style (A) (mm)

| Pitch Code | A                   | B   | C   | D  | E    |
|------------|---------------------|-----|-----|----|------|
| F          | 2,5                 | 5,0 | 7,5 | 10 | 12,5 |
| L          | only 20mm long lead |     |     |    |      |
| d          | 0,5 or 0,6 or 0,8mm |     |     |    |      |
| e          | max. 4,0mm          |     |     |    |      |

**Y1 AC Ceramic Capacitor  
400VAC**

Part No.: **I22002**

|       |        |      |        |        |        |           |           |      |            |
|-------|--------|------|--------|--------|--------|-----------|-----------|------|------------|
| DRW:  | Jason  | CHKD | Wilson | MATL:  | Wilson | TOLERANCE | Mason     | DATE | 01.11.2010 |
| APPD: | Schumi |      |        | FINISH | Jamy   |           | Sheet No. |      | 2 from 13  |

Customer:

# EDCON-COMPONENTS



## Lead Style Informations

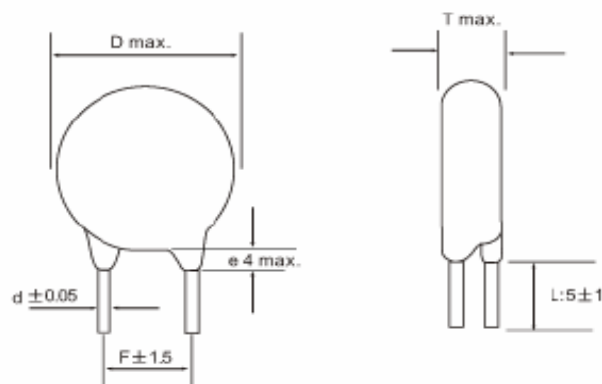

## Lead Style Informations



## Lead Style Informations



### Lead Code Style (B) Unit (mm)

| Pitch Code | A                            | B   | C   | D  | E    |
|------------|------------------------------|-----|-----|----|------|
| F          | 2,5                          | 5,0 | 7,5 | 10 | 12,5 |
| L          | 5,0mm or on customer request |     |     |    |      |
| d          | 0,5 or 0,6 or 0,8mm          |     |     |    |      |
| e          | max. 4,0mm                   |     |     |    |      |

### Lead Code Style (C) Unit (mm)

| Pitch Code |                              | B   | C   | D   | E    |
|------------|------------------------------|-----|-----|-----|------|
| F          |                              | 5,0 | 7,5 | 10  | 12,5 |
| A          |                              | 5,0 | 5,0 | 6,5 | 6,5  |
| L          | 5,0mm or on customer request |     |     |     |      |
| d          | 0,5 or 0,6 or 0,8mm          |     |     |     |      |

### Lead Code Style (D) Unit (mm)

| Pitch Code |                     | B   | C   | D   | E    |
|------------|---------------------|-----|-----|-----|------|
| F          |                     | 5,0 | 7,5 | 10  | 12,5 |
| A          |                     | 5,0 | 5,0 | 6,5 | 6,5  |
| L          | 20mm min.           |     |     |     |      |
| d          | 0,5 or 0,6 or 0,8mm |     |     |     |      |

**Y1 AC Ceramic Capacitor  
400VAC**

Part No.: **I22002**

|       |        |      |        |        |        |           |           |      |            |
|-------|--------|------|--------|--------|--------|-----------|-----------|------|------------|
| DRW:  | Jason  | CHKD | Wilson | MATL:  | Wilson | TOLERANCE | Mason     | DATE | 01.11.2010 |
| APPD: | Schumi |      |        | FINISH | Jamy   |           | Sheet No. |      | 3 from 13  |

Customer:

# EDCON-COMPONENTS



## Lead Style Informations

## Lead Style Informations



### Lead Code Style (H) Unit (mm)

| Pitch Code | B                            | C   | D  | E    |
|------------|------------------------------|-----|----|------|
| F          | 5,0                          | 7,5 | 10 | 12,5 |
| L          | 5,0mm or on customer request |     |    |      |
| d          | 0,5 or 0,6 or 0,8mm          |     |    |      |

### Lead Code Style (M) Unit (mm)

| Pitch Code | B                            | C    | D    | E    |
|------------|------------------------------|------|------|------|
| F          | 5,0                          | 7,5  | 10   | 12,5 |
| H          | 2,6                          | 2,6  | 3,3  | 3,3  |
| P1         | 1,3                          | 1,25 | 1,65 | 1,65 |
| P2         | 1,7                          | 1,65 | 1,95 | 1,95 |
| A          | D<8: 6,0± 1,5, D>8: 7,0± 1,5 |      |      |      |
| L          | 3,0 ~ 30mm                   |      |      |      |
| d          | 0,5 or 0,6 or 0,8mm          |      |      |      |

**Y1 AC Ceramic Capacitor  
400VAC**

Part No.: **I22002**

|       |        |      |        |        |        |           |           |      |            |
|-------|--------|------|--------|--------|--------|-----------|-----------|------|------------|
| DRW:  | Jason  | CHKD | Wilson | MATL:  | Wilson | TOLERANCE | Mason     | DATE | 01.11.2010 |
| APPD: | Schumi |      |        | FINISH | Jamy   |           | Sheet No. |      | 4 from 13  |

Customer:

# EDCON-COMPONENTS



## Specification and test method

Operating Temperature range  $-25^{\circ}\text{C} \sim +105^{\circ}\text{C}$   
 But temperature range is  $-25\% \sim +85^{\circ}\text{C}$  at safety standard specification.

Test and measurement shall be made at the standard condition.  
 ( Temperature  $15 \sim 35^{\circ}\text{C}$  relative humidity  $45 \sim 75\%$  and atmospheric pressure  $860 \sim 1060\text{hpa}$ ). Unless otherwise specified herein it doubt accurated on the value of measurement, and remesurement was requested by customer capacitor shall be measured at the reference condition ( Temperature  $20 \pm 2^{\circ}\text{C}$ , relative humidity  $60 \sim 70\%$  and atmospheric pressure  $860 \sim 1060\text{hpa}$ ). unless otherwise specified herein.

## Leakage Current Characteristics

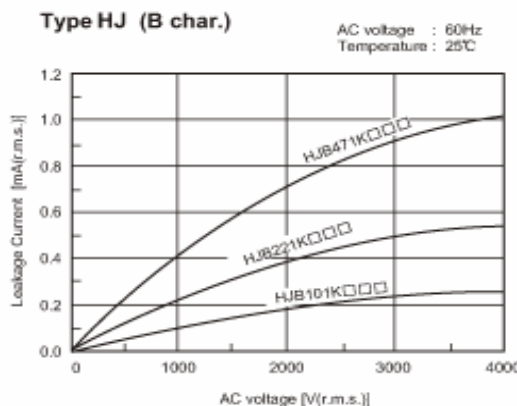

## Capacitance Temperature Characteristics



## Impedance vs. Frequency Characteristics

Type HJ

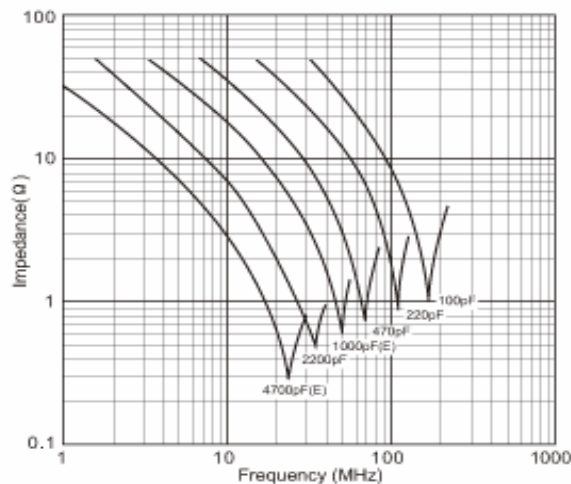

Type HJ (E char.)

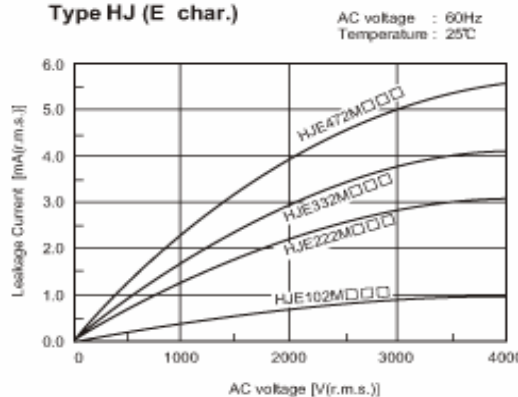

Char: B(Y5P)

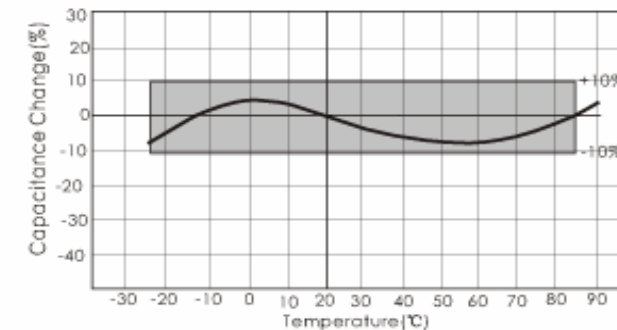

**Y1 AC Ceramic Capacitor  
400VAC**

Part No.: **I22002**

|       |        |      |        |        |        |           |           |           |            |
|-------|--------|------|--------|--------|--------|-----------|-----------|-----------|------------|
| DRW:  | Jason  | CHKD | Wilson | MATL:  | Wilson | TOLERANCE | Mason     | DATE      | 01.11.2010 |
| APPD: | Schumi |      |        | FINISH | Jamy   |           | Sheet No. | 5 from 13 | Customer:  |

# EDCON-COMPONENTS

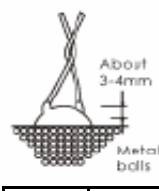

| Item                      | Specification   | Testing Method   |
|---------------------------|---|--|
| Appearance and Dimensions | No marked defect on appearance from and dimension are within specified range. | The capacitor shall be inspected by naked eyes for visible evidence of defect. Dimensions shall be measured with slide calipers.   |
| Marking                   | To be easily legible.   | The capacitor shall be inspected by naked eyes   |
| Capacitance               | Within specified tolerance  | The capacitance, dissipation shall be measured at $25 \pm 2^\circ\text{C}$ with $1 \pm 0,1\text{KHz}$ and $\text{AC}1 \pm 0,1\text{V}$ (r.m.s)   |
| Dissipation Factor (D,F)  | Char. Specification   |  |
|                           | B= $D,F \leq 2,5\%$<br>E= $D,F \leq 2,5\%$                                    |  |
| Insulation Resistance (R) | 10000M $\Omega$ min.  | The insulation resistance shall be measured with DC $500 \pm 50\text{V}$ within $60 \pm 5\text{sec}$ . Of charging.  |
| Dielectric Strength       | Between Lead wires  | No failure<br>The capacitor shall not be damage when AC 500V (r.m.s.) are applied between the lead wires for 600s.   |
|                           | Body Insulation   | No failure<br>First, the terminals of the capacitor shall be connected together. Then as shown in Figure right, a metal foil shall be closely wrapped around the body of the capacitor to the distance of about 3-4mm from each terminal. Then the capacitor shall be inserted into a container filled with balls of about 1mm diameter. Finally AC 400(r.m.s.) is applied for 60s between the capacitor lead wires and metal balls.<br> |

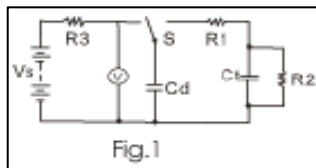
| Item                        | Specification   | Testing Method   |  |                                  |
|-----------------------------|---|--|--|----------------------------------|
| Temperature Characteristics | Char. Capacitance Change  | The capacitance measurement shall be made of each step specified in table 3. |  |                                  |
|                             | B   | within $\pm 10\%$  | Step   | Temperature ( $^\circ\text{C}$ ) |
|                             | E   | within $+ 20\% -55\%$  | 1  | $+ 20 \pm 2$                     |
|                             | Temperature characteristics guarantee is $-25$ to $+85^\circ\text{C}$ |  | 2  | $- 25 \pm 2$                     |
|                             |   |  | 3  | $+ 20 \pm 2$                     |
|                             |   | 4  | $+ 85 \pm 2$   |                                  |
|                             |   | 5  | $+ 20 \pm 2$   |                                  |
| Discharge test (1)          | Appearance  | No marked defect.  | As in figure , discharge in made 50 times at 5sec intervals from the capacitor (Cd) charged at DC voltage of specified<br><br>Fig.1 |                                  |
|                             | I.R.  | 1000M $\Omega$ min.  |  |                                  |
|                             | Dielectric Strength   | per Item 6.  |  |                                  |

## Y1 AC Ceramic Capacitor 400VAC

Part No.: **I22002**

|       |        |      |        |        |        |           |       |           |            |
|-------|--------|------|--------|--------|--------|-----------|-------|-----------|------------|
| DRW:  | Jason  | CHKD | Wilson | MATL:  | Wilson | TOLERANCE | Mason | DATE      | 01.11.2010 |
| APPD: | Schumi |      |        | FINISH | Jamy   |           |       | Sheet No. | 6 from 13  |

Customer:

# EDCON-COMPONENTS



| Item   | Specification   | Testing Method   | Item                   | Specification   | Testing Method   |  |       |               |            |             |               |
|--|---|--|------------------------|---|--|--|-------|---------------|------------|-------------|---------------|
| Discharge Trest II   | The cheese-cloth around capacitors shall not glow or flame. | <p>A single layer of cheese cloth is to be placed around the body of the test capacitor. Each sample is to be subjected to four discharges from a dump capacitor charged to a voltage that. When discharged, placed DC 5KV across the capacitor under test. The interval between successive discharge is to be 5s. AC240V (r.m.s.)-60Hz potential is to applied across the capacitor under test and is to be maintained for 30s. after the fourth discharge, unless the circuit is opened in a shorter time by breakdown of the capacitor. The direct current supply is to be adjusted to provide a potential in accordance with the following.</p> <div style="text-align: center;"> <math display="block">V_{dc} = \frac{5000(C_d + C_t)}{C_d} (V)</math> <p>Fig.2</p> </div> <p>Vdc: Variable direct-current voltage source.</p> <p>s: High voltage switch</p> <p>L: Choke coil of appr. 3mH and 0,03Ω</p> <p>F: Plug fuse rated 30A and 250V</p> <p>Vac.: supply source rated 240V 60Hz 30A</p> <p>C1: Capacitor under test.</p> <p>Cd: Dump Capacitor</p> | Discharge Trest II     | The cheese-cloth around capacitors shall not glow or flame.   | Capacitance value and D.F. are follows.  |  |       |               |            |             |               |
|  |   |  |                        |   | Cap. Value Cd to 0,005μF 0,0051 to 0,05μF  |  |       |               |            |             |               |
| Discharge Trest II   | The cheese-cloth around capacitors shall not glow or flame. | <p>A single layer of cheese cloth is to be placed around the body of the test capacitor. Each sample is to be subjected to four discharges from a dump capacitor charged to a voltage that. When discharged, placed DC 5KV across the capacitor under test. The interval between successive discharge is to be 5s. AC240V (r.m.s.)-60Hz potential is to applied across the capacitor under test and is to be maintained for 30s. after the fourth discharge, unless the circuit is opened in a shorter time by breakdown of the capacitor. The direct current supply is to be adjusted to provide a potential in accordance with the following.</p> <div style="text-align: center;"> <math display="block">V_{dc} = \frac{5000(C_d + C_t)}{C_d} (V)</math> <p>Fig.2</p> </div> <p>Vdc: Variable direct-current voltage source.</p> <p>s: High voltage switch</p> <p>L: Choke coil of appr. 3mH and 0,03Ω</p> <p>F: Plug fuse rated 30A and 250V</p> <p>Vac.: supply source rated 240V 60Hz 30A</p> <p>C1: Capacitor under test.</p> <p>Cd: Dump Capacitor</p> | Solderability of leads | Lead wire shall be soldered with uniformly coated on the axial direction over 3/4 of the circumferential direction. | The lead wire of capacitor shall be dipped into molten solder of 235 ± 5°C for 2 ± 0,5s. The depth of immersion is up to about 1,5 to 2,0mm from the root of lead wires.   |  |       |               |            |             |               |
|  |   |  |                        |   | D.F of Cd. 0,5% max. 0,5%max.  |  |       |               |            |             |               |
| Discharge Trest II   | The cheese-cloth around capacitors shall not glow or flame. | <p>A single layer of cheese cloth is to be placed around the body of the test capacitor. Each sample is to be subjected to four discharges from a dump capacitor charged to a voltage that. When discharged, placed DC 5KV across the capacitor under test. The interval between successive discharge is to be 5s. AC240V (r.m.s.)-60Hz potential is to applied across the capacitor under test and is to be maintained for 30s. after the fourth discharge, unless the circuit is opened in a shorter time by breakdown of the capacitor. The direct current supply is to be adjusted to provide a potential in accordance with the following.</p> <div style="text-align: center;"> <math display="block">V_{dc} = \frac{5000(C_d + C_t)}{C_d} (V)</math> <p>Fig.2</p> </div> <p>Vdc: Variable direct-current voltage source.</p> <p>s: High voltage switch</p> <p>L: Choke coil of appr. 3mH and 0,03Ω</p> <p>F: Plug fuse rated 30A and 250V</p> <p>Vac.: supply source rated 240V 60Hz 30A</p> <p>C1: Capacitor under test.</p> <p>Cd: Dump Capacitor</p> | Vibration Resistance   | No market defect<br>Within the specified tolerance  | The capacitor shall firmly be soldered to the supporting lead wire and vibration which is 10 to 55Hz in the vibration frequency range. 1,5mm in total amplitude, and about 1min in the rate of vibration change from 10Hz to 55Hz and back to 10Hz is applied for a total of 6H; 2H each in 3 mutually perpendicular directions. |  |       |               |            |             |               |
|  |   |  |                        |   |  | <table border="1" style="width: 100%; border-collapse: collapse;"> <tr> <th style="width: 10%;">Char.</th> <th style="width: 90%;">Specification</th> </tr> <tr> <td>B</td> <td>D,F, ≤ 2,5%</td> </tr> <tr> <td>E</td> <td>D,F, ≤ 2,5%</td> </tr> </table> | Char. | Specification | B          | D,F, ≤ 2,5% | E             |
| Char.  | Specification   |  |                        |   |  |  |       |               |            |             |               |
| B  | D,F, ≤ 2,5%   |  |                        |   |  |  |       |               |            |             |               |
| E  | D,F, ≤ 2,5%   |  |                        |   |  |  |       |               |            |             |               |
| <table border="1" style="width: 100%; border-collapse: collapse;"> <tr> <td colspan="2" style="text-align: center;"><b>Y1 AC Ceramic Capacitor</b></td> </tr> <tr> <td colspan="2" style="text-align: center;"><b>400VAC</b></td> </tr> <tr> <td style="width: 70%;">Part No.:</td> <td style="text-align: right;"><b>I22002</b></td> </tr> </table> |   |  |                        |   |  | <b>Y1 AC Ceramic Capacitor</b>   |       | <b>400VAC</b> |            | Part No.:   | <b>I22002</b> |
| <b>Y1 AC Ceramic Capacitor</b>   |   |  |                        |   |  |  |       |               |            |             |               |
| <b>400VAC</b>  |   |  |                        |   |  |  |       |               |            |             |               |
| Part No.:  | <b>I22002</b>   |  |                        |   |  |  |       |               |            |             |               |
| DRW:   | Jason   | CHKD   | Wilson                 | MATL:   | Wilson   | TOLERANCE  | Mason | DATE          | 01.11.2010 | Customer:   |               |
| APPD:  | Schumi  |  |                        | FINISH  | Jamy   |  |       | Sheet No.     | 7 from 13  |             |               |

# EDCON-COMPONENTS

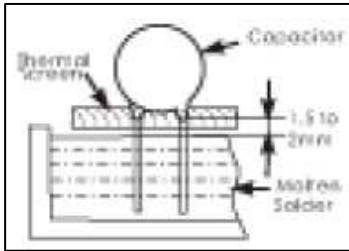

| Item             |                     | Specification       | Testing Method   |
|------------------|---------------------|---------------------|--|
| Soldering Effect | Appearance          | No marked defect    | As in figure, the lead wires shall be immersed solder of $350 \pm 10^\circ\text{C}$ or $260 \pm 5^\circ\text{C}$ up to 1,5 ~ 2,0mm from the root of the terminal for $3,5 \pm 0,5\text{s}$ . ( $10 \pm 1\text{s}$ for $260 \pm 5^\circ\text{C}$ ).   |
|                  | Capacitance change  | Within $\pm 10\%$   |  |
|                  | I.R.                | 1000M $\Omega$ min. |  |
|                  | Dielectric Strength | Pre Item 6.         |  <p>Pre-treatment:<br/>Capacitor shall be stored at <math>85 \pm 2^\circ\text{C}</math> for 1h. Then placed at room conditions for <math>24 \pm 2\text{h}</math> before initial measurements.</p> <p>Post-treatment:<br/>Capacitor shall be stored for 1 to 2 h at room conditions.</p> |

| Item                           |                     | Specification            | Testing Method   |  |
|--------------------------------|---------------------|--------------------------|--|--|
| Humidity ( Under Steady State) | Appearance          | No marked defect.        | Set the capacitor for $500 \pm 12\text{h}$ at $40 \pm 2^\circ\text{C}$ in 90 ~ 95% relative humidity. Post-treatment: Capacitor shall be stored for 1 to 2h at room condition. |  |
|                                | Capacitance Change  | Char. Capacitance Change |  |  |
|                                |                     | B                        |  | within $\pm 10\%$  |
|                                |                     | E                        |  | within $\pm 15\%$  |
|                                | D,F,                | Char. Specification      |  |  |
|                                |                     | B                        |  | D.F. $\leq 5,0\%$  |
|                                |                     | E                        |  | D.F. $\leq 5,0\%$  |
| I.R.                           | 3000M $\Omega$ min. |                          |  |  |
| Dielectric Strength            | Per Item 6          |                          |  |  |
| Humidity Loading               | Appearance          | No marked defect.        |  | Apply the rated voltage for $500 \pm 12\text{h}$ at $40 \pm 2^\circ\text{C}$ in 90 ~ 95% relative humidity. Post-treatment: Capacitor shall be stored for 1 to 2h at room condition. |
|                                | Capacitance Change  | Char. Capacitance Change |  |  |
|                                |                     | B                        | within $\pm 10\%$  |  |
|                                |                     | E                        | within $\pm 15\%$  |  |
|                                | D,F,                | Char. Specification      |  |  |
|                                |                     | B                        | D.F. $\leq 5,0\%$  |  |
|                                |                     | E                        | D.F. $\leq 5,0\%$  |  |
| I.R.                           | 3000M $\Omega$ min. |                          |  |  |
| Dielectric Strength            | Per Item 6          |                          |  |  |

**Y1 AC Ceramic Capacitor  
400VAC**

Part No.: **I22002**

|       |        |      |        |        |        |           |           |           |            |
|-------|--------|------|--------|--------|--------|-----------|-----------|-----------|------------|
| DRW:  | Jason  | CHKD | Wilson | MATL:  | Wilson | TOLERANCE | Mason     | DATE      | 01.11.2010 |
| APPD: | Schumi |      |        | FINISH | Jamy   |           | Sheet No. | 8 from 13 | Customer:  |



# EDCON-COMPONENTS



| Item                | Specification       | Testing Method  |
|---------------------|---------------------|---|
| Life                | Appearance          | No marked defect.   |
|                     | Capacitance Change  | Within $\pm 20\%$   |
|                     | I.R.                | 3000M $\Omega$ min.   |
|                     | Dielectric Strength | Per Item 6.   |
| Discharge Test (II) | Per Item 9.         | <p>Impulse Voltage</p> <p>Each individual Capacity shall be subjected to 8KV impulses for three times. After the capacitance are supplied to life test.</p> <p><math>T1 = 1.2 \mu s</math><br/><math>T2 = 50 \mu s</math></p> <p>Apply a voltage of table 4 for 1000h at 105 <math>\pm 2/0^\circ C</math>, and relative humidity of 50% max. (table 4)</p> <p>Applied Voltage</p> <p>AC 425V (r.m.s.). Except that once each hour the voltage is increased to AC 1000V (r.m.s.) for 0,1s.</p> <p>Post-treatment: Capacitor shall be stored for 1 to 2h at room temperature.</p> |

| Item                      | Specification                                | Testing Method  |          |
|---------------------------|--|---|----------|
| Flame Test                | The capacitor flame discontinues as follows. | <p>The Capacitor shall be subjected to applied flame for 15s and then removed for 15 s until 5 cycle.</p> <p>Gas Burner (in mm)</p>   |          |
|                           | Cycle  |   | Time     |
|                           | 1 to 4                                       |   | 30s max. |
| 5                         | 60s. Max                                     |   |          |
| Robustness of Termination | Tensile                                      | <p>Lead wire shall not cut off. Capacitor shall not be broken.</p>  |          |
|                           | Bending                                      |   |          |
| Active Flammability       | The chees-cloth shall not be on fire.        | <p>Each lead wire shall be subjected to 5N weight and then a 90° bend, at the point of egress, in one direction, return to original position, and then a 90° bend in the opposite direction at the rate of one bend in 2 to 3s.</p> |          |

**Y1 AC Ceramic Capacitor  
400VAC**

Part No.: **I22002**

|       |        |      |        |        |        |           |           |           |            |
|-------|--------|------|--------|--------|--------|-----------|-----------|-----------|------------|
| DRW:  | Jason  | CHKD | Wilson | MATL:  | Wilson | TOLERANCE | Mason     | DATE      | 01.11.2010 |
| APPD: | Schumi |      |        | FINISH | Jamy   |           | Sheet No. | 9 from 13 | Customer:  |

# EDCON-COMPONENTS



| Item                                      |  | Specification |  | Testing Method |           | Item      |                      | Specification   |   | Testing Method   |  |   |  |  |           |        |  |           |  |  |
|---|--|---------------|--|----------------|-----------|-----------|----------------------|---|---|--|--|---|--|--|-----------|--------|--|-----------|--|--|
| Active Flammability                       | The cheese-cloth shall not be on fire. |               | The capacitor shall be individually wrapped in at least one but more than two complete layers of cheese-cloth. The capacitor shall be subjected to 20 discharges. The interval between successive discharges shall be 5s. The UAC shall be maintained for 2min after the last discharge. |                |           |           | Passive Flammability | The burning time shall not be exceeded the time 30s. The tissue paper shall not ignite. |   | The capacitor under test shall be held in the flame in the position which best promotes burning. Each specimen shall only be exposed once to the flame. Time of exposure to flame: 30s.<br><br>Length of flame: 12± 1mm.<br>Gas burner: Length 35mm min.<br>Inside Dia: 0,5 ± 0,1mm-<br>Outside Dia. 0,9mm max.<br>Gas: Butane gas Purity 95% min. |  |   |  |  |           |        |  |           |  |  |
|   | The cheese-cloth shall not be on fire  |               | C1,2: 1µF ±10%<br>C3: 0,033µ ± 5% 10KV<br>Ct: 3µF ± 5% 10KV<br>Cx: Capacitor under test<br>F: Fuse rated 10A<br>L1 to 4: 1,5mH ± 20%<br>16A Rod core choke<br>R: 100Ω ±2%<br>UAC: UR ±5%<br>UR: Rated Voltage<br>Ut: Voltage applied to Ct   |                |           |           |                      |   |   |  |  |   |  |  |           |        |  |           |  |  |
| DRW: Jason                                |  | CHKD          | Wilson   | MATL: Wilson   | TOLERANCE | Mason     | DATE                 | 01.11.2010  | <table border="1"> <tr> <td colspan="3" style="text-align: center;"><b>Y1 AC Ceramic Capacitor<br/>400VAC</b></td> </tr> <tr> <td>Part No.:</td> <td colspan="2">I22002</td> </tr> <tr> <td>Customer:</td> <td colspan="2"></td> </tr> </table> |  |  | <b>Y1 AC Ceramic Capacitor<br/>400VAC</b> |  |  | Part No.: | I22002 |  | Customer: |  |  |
| <b>Y1 AC Ceramic Capacitor<br/>400VAC</b> |  |               |  |                |           |           |                      |   |   |  |  |   |  |  |           |        |  |           |  |  |
| Part No.:                                 | I22002                                 |               |  |                |           |           |                      |   |   |  |  |   |  |  |           |        |  |           |  |  |
| Customer:                                 |  |               |  |                |           |           |                      |   |   |  |  |   |  |  |           |        |  |           |  |  |
| APPD: Schumi                              |  |               |  | FINISH: Jamy   |           | Sheet No. |                      | 10 from 13  |   |  |  |   |  |  |           |        |  |           |  |  |

# EDCON-COMPONENTS



| Item                            |                    | Specification    |   | Testing Method  |                  |                 |  |                   |  |  |  |
|---------------------------------|--------------------|------------------|---|---|------------------|-----------------|--|-------------------|--|--|--|
| Temperature and Immersion Style | Appearance         | No marked defect |   | The capacitor shall be subjected to 5 temperature cycles, then consecutively to 2 immersion cycles. |                  |                 |  |                   |  |  |  |
|                                 | Capacitance Change | Char.            | Capaci.Change   |   |                  |                 |  | Temperature cycle |  |  |  |
|                                 |                    | B                | Within ± 10%  |   |                  |                 |  |                   |  |  |  |
|                                 |                    | E                | Within ± 20%  |   |                  |                 |  |                   |  |  |  |
|                                 | D.F.               |                  |   | Step  | Temperature (°C) | Time            |  |                   |  |  |  |
|                                 |                    |                  |   | 1   | . -25 +0/-3      | 30min           |  |                   |  |  |  |
|                                 |                    | Char.            | Specification   | 2   | Room temperature | 3min            |  |                   |  |  |  |
|                                 |                    | B                | D.F. ≤ 5,0%   | 3   | . + 105 +3/0     | 30min           |  |                   |  |  |  |
|                                 |                    | E                | D.F. ≤ 5,0%   | 4   | Room temperature | 3min            |  |                   |  |  |  |
|                                 |                    |                  | Cycle time: 5cycle<br>Immersion cycle   |   |                  |                 |  |                   |  |  |  |
| I.R.                            | 3000M Ω min.       |                  | Step  | Temperature (°C)  | Time             | Immersion Water |  |                   |  |  |  |
| Dielectric Strength             | Per Item 6         |                  | 1   | . +65 +/-0  | 15min            | Clean Water     |  |                   |  |  |  |
|                                 |                    |                  | 2   | Room Temp.  | 15min.           | Salt Water      |  |                   |  |  |  |
|                                 |                    |                  | Pre-treatment: Capacitor shall be stored at 85 ±2°C for 1h, then placed at room conditions for 24 ± 2h. |   |                  |                 |  |                   |  |  |  |
|                                 |                    |                  | Post-treatment: Capacitor shall be stored for 24 ± 2h at room conditions.                               |   |                  |                 |  |                   |  |  |  |

"Room Condition" Temperature 15 to 35°C, Relative humidity; 45 to 75%, Atmospheric pressure: 6 to 106KPa.

**Y1 AC Ceramic Capacitor  
400VAC**

Part No.: **I22002**

|       |        |      |        |        |        |           |           |            |            |
|-------|--------|------|--------|--------|--------|-----------|-----------|------------|------------|
| DRW:  | Jason  | CHKD | Wilson | MATL:  | Wilson | TOLERANCE | Mason     | DATE       | 01.11.2010 |
| APPD: | Schumi |      |        | FINISH | Jamy   |           | Sheet No. | 11 from 13 |            |

Customer:

# EDCON-COMPONENTS



## Ordering Informations

| Serie | Range | Temperature Character. | Voltage | Tolerance Code | Lead Style Code | Lead Length Code | Lead Space Code | ROHS | Packing Code |  |
|-------|-------|------------------------|---------|----------------|-----------------|------------------|-----------------|------|--------------|--|
|-------|-------|------------------------|---------|----------------|-----------------|------------------|-----------------|------|--------------|--|

|               |            |          |            |          |          |           |          |          |           |  |
|---------------|------------|----------|------------|----------|----------|-----------|----------|----------|-----------|--|
| <b>I22002</b> | <b>222</b> | <b>E</b> | <b>401</b> | <b>M</b> | <b>A</b> | <b>20</b> | <b>D</b> | <b>R</b> | <b>BU</b> |  |
|---------------|------------|----------|------------|----------|----------|-----------|----------|----------|-----------|--|

|                    |               |                    |               |                   |                       |                  |                            |                           |
|--------------------|---------------|--------------------|---------------|-------------------|-----------------------|------------------|----------------------------|---------------------------|
| <b>222=</b> 2200pf |               | <b>401=</b> 400VAC |               | <b>A=</b> Style A | <b>20=</b> 20mm       | <b>A=</b> 2,50mm | <b>R=</b> ROHS Conform     | <b>BU=</b> Bulk Ware      |
|                    | <b>E=</b> Y5U |                    | <b>M=</b> 20% | <b>B=</b> Style B | <b>05=</b> 5mm / ±1mm | <b>B=</b> 5,00mm | <b>N=</b> NON ROHS Conform | <b>TA=</b> Tape Ammo Pack |
|                    |               |                    |               | <b>C=</b> Style C |                       | <b>C=</b> 7,50mm |                            | <b>TR=</b> Tape Reel      |
|                    |               |                    |               | <b>D=</b> Style D |                       | <b>D=</b> 10,0mm |                            |                           |
|                    |               |                    |               | <b>H=</b> Style H |                       | <b>E=</b> 12,5mm |                            |                           |
|                    |               |                    |               | <b>M=</b> Style M |                       |                  |                            |                           |

**Y1 AC Ceramic Capacitor  
400VAC**

Part No.: **I22002**

Customer:

|       |        |      |        |        |        |           |           |      |            |
|-------|--------|------|--------|--------|--------|-----------|-----------|------|------------|
| DRW:  | Jason  | CHKD | Wilson | MATL:  | Wilson | TOLERANCE | Mason     | DATE | 01.11.2010 |
| APPD: | Schumi |      |        | FINISH | Jamy   |           | Sheet No. |      | 12 from 13 |



Soldering Profile Curve

Classification Reflow Profile (JEDEC J-STD-020C)



**Y1 AC Ceramic Capacitor  
400VAC**

Part No.: **I22002**

|       |        |      |        |        |        |           |           |            |            |
|-------|--------|------|--------|--------|--------|-----------|-----------|------------|------------|
| DRW:  | Jason  | CHKD | Wilson | MATL:  | Wilson | TOLERANCE | Mason     | DATE       | 01.11.2010 |
| APPD: | Schumi |      |        | FINISH | Jamy   |           | Sheet No. | 13 from 13 | Customer:  |