

# EDCON-COMPONENTS



The Power of LED Light



## Dimensions / Informations

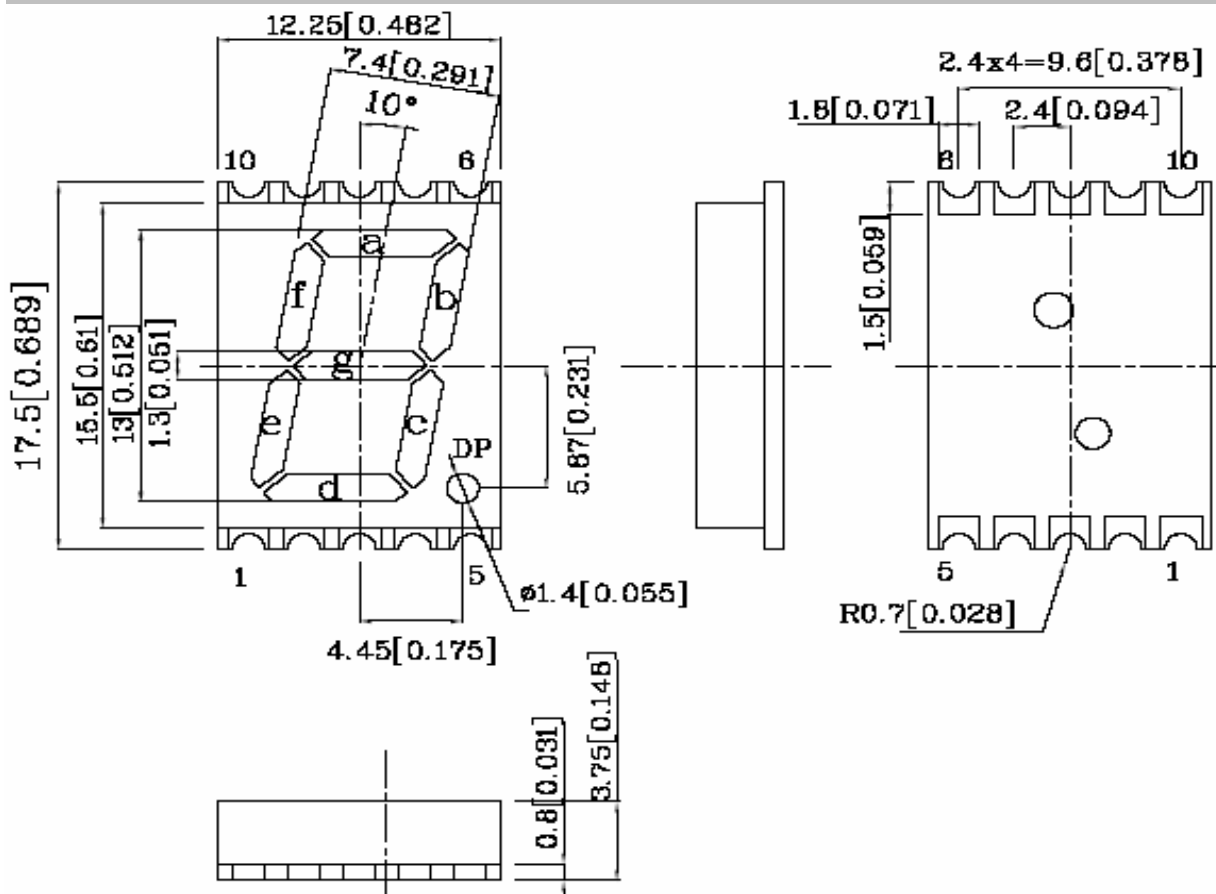

## Features

- Low Current Operation
- Excellent Character appearance
- Easy mounting on P.C. Board or Sockets
- Standard High Brightness
- Mechanical Rugged
- Gray Face / White Segment
- Moisture Sensitivity Level: Level 4

## Diode Drive Construction

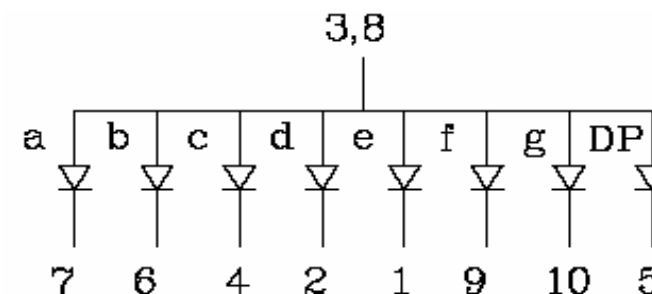

All Dimensions are in millimeters (inches).  
Tolerance is +/- 0,25 (0,01") unless otherwise specified.  
Specifications are subject to change without notice.

**SMT Segment Display Digit  
Height 13,00mm**

Part No.: **M21D1005**

DRW:	Jason	CHKD	Wilson	MATL:	Wilson	TOLERANCE	Mason	DATE	30.09.2010	Customer:
APPD:	Schumi			FINISH	Jamy		Sheet No.	1 from 7		

[www.edcon-components.com](http://www.edcon-components.com)

email: [info@edcon-components.com](mailto:info@edcon-components.com)

# EDCON-COMPONENTS



The Power of LED Light



## Tape specifications

## P.C.B. Layout

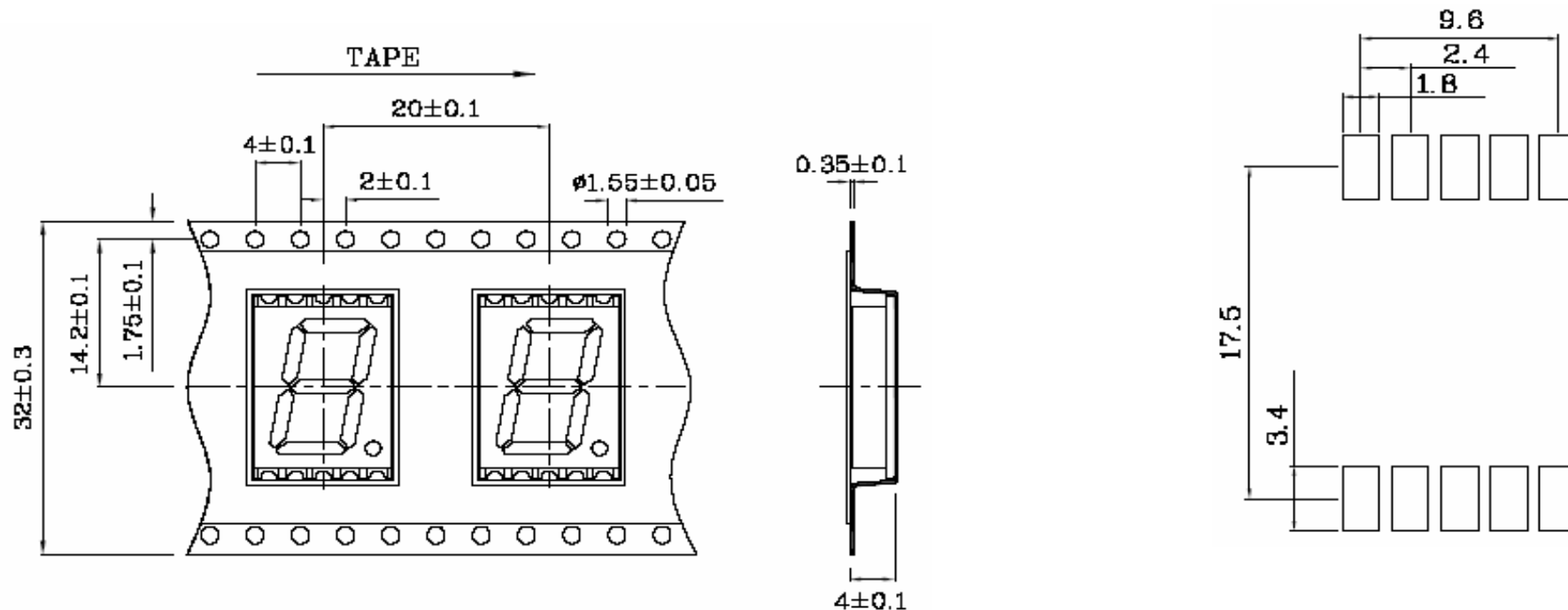

**SMT Segment Display Digit  
Height 13,00mm**

Part No.: **M21D1005**

DRW:	Jason	CHKD	Wilson	MATL:	Wilson	TOLERANCE	Mason	DATE	30.09.2010
APPD:	Schumi			FINISH	Jamy		Sheet No.	2 from 7	Customer:

# EDCON-COMPONENTS



The Power of LED Light



## Description

Part Number	Emitting Color	Emitting Material	Luminous Intensity IF=10mA $\mu$ cd		Wavelength nm	Description
			min	max,		
M21D1005	Orange	InGaAlP	12000	57990	610	Commun Anode Right Hand Decimal Point

Operating Characteristics (TA=25°C)		InGaAlP	Unit
Forward Voltage (typ). (IF=10mA)	VF	2,0	V
Forward Voltage (typ). (IF=10mA)	VF	2,5	V
Reverse Current (Max.) (Vr=5V)	IR	10	$\mu$ A
Wavelength of Peak Emission (typ. If=10mA)	P	610	nm
Wavelength / Dominant Emission (typ. If=10mA)	D	601	nm
Spectral Line Full Width at Half-Maximum (typ. 10mA)	$\Delta$	29	nm
Capacitance (typ) (Vf=0V, f=1Mhz)	C	15	pF

Absolute Maximum Ratings (TA=25°C)		InGaAlP	Unit
Reverse Voltage	VF	5	V
Forward Current	IF	30	mA
Forward Current (peak) 1/10Duty Cycle 0,1ms Pulse Width	iFS	195	mA
Power Dissipation	PT	75	mW
Operating Temperature	TA	-.40 ~+85	°C
Storage Temperature	Tstg	-.40 ~+85	

**SMT Segment Display Digit  
Height 13,00mm**

Part No.: **M21D1005**

DRW:	Jason	CHKD	Wilson	MATL:	Wilson	TOLERANCE	Mason	DATE	30.09.2010	Customer:
APPD:	Schumi			FINISH	Jamy		Sheet No.	3 from 7		

# EDCON-COMPONENTS



The Power of LED Light



## Characteristics

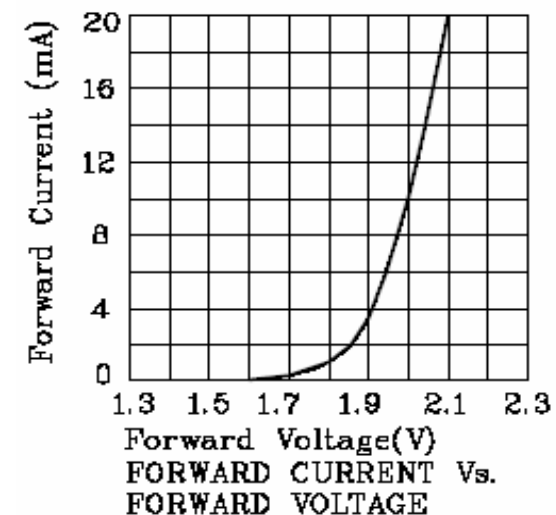
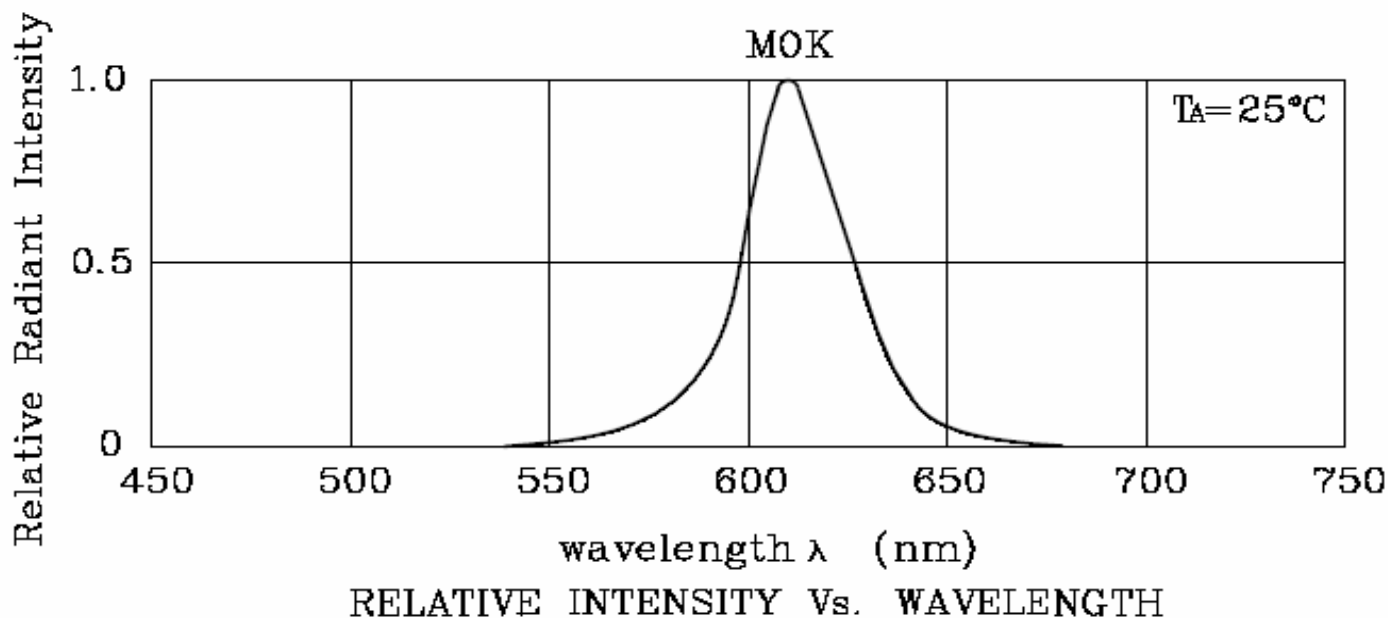

**SMT Segment Display Digit  
Height 13,00mm**

Part No.: **M21D1005**

DRW:	Jason	CHKD	Wilson	MATL:	Wilson	TOLERANCE	Mason	DATE	30.09.2010	Customer:
APPD:	Schumi			FINISH	Jamy		Sheet No.	4 from 7		



The Power of LED Light



## Characteristics

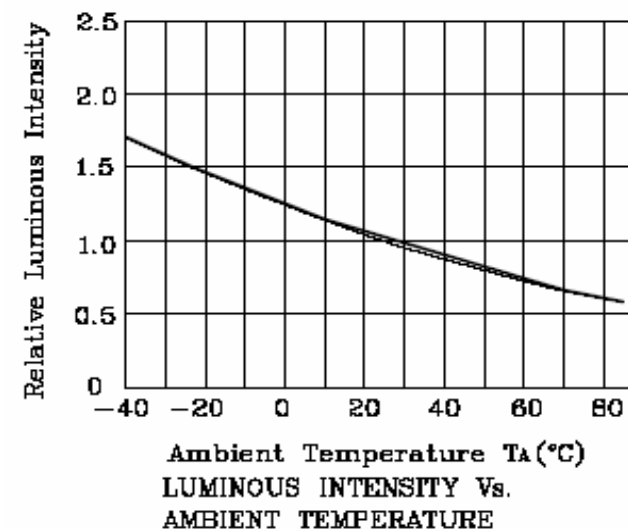
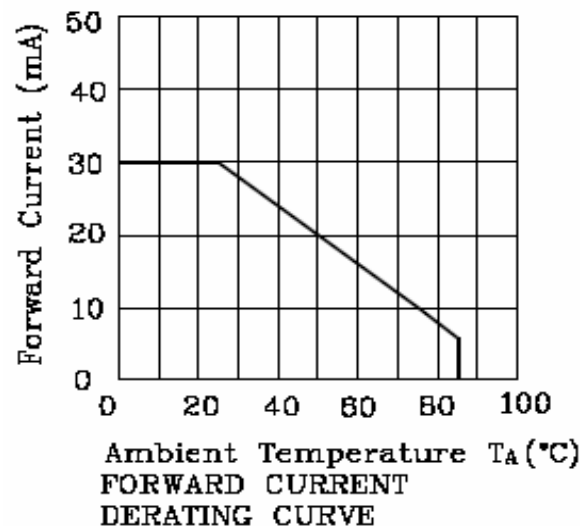
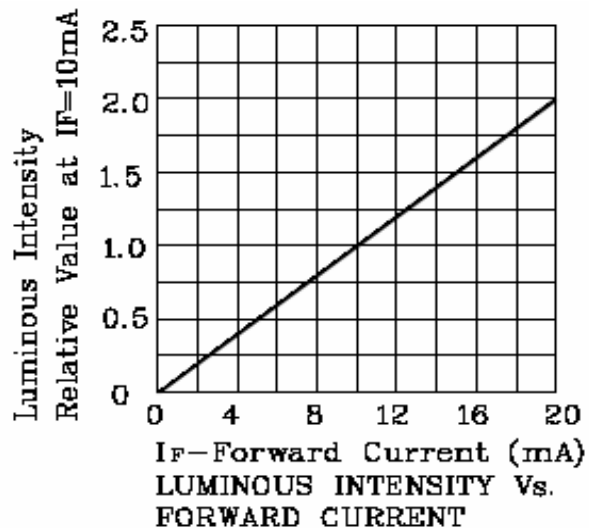

Is special sorting is required (e.g. binning based on forward voltage. Luminous intensity /luminous flux, or wavelength). the typical accuracy of the sorting process is as follows.

Wavelength: +/-1nm

Luminous Intensity / Luminous Flux: +/- 15%

Forward Voltage: +/-0,1V

Note: Accuracy may depend on the sorting parameters.

**SMT Segment Display Digit  
Height 13,00mm**

Part No.: **M21D1005**

Customer:

DRW:	Jason	CHKD	Wilson	MATL:	Wilson	TOLERANCE	Mason	DATE	30.09.2010
APPD:	Schumi			FINISH	Jamy		Sheet No.	5 from 7	

# EDCON-COMPONENTS



The Power of LED Light



## Ordering Informations

Serie	Digit Height Code	Quantity of Digits	Model Number	Diode Drive Code	Emitting Color (nm)	Surface Color Code	Segment Color Code	No Function	ROHS	Package
<b>M21D1005</b>	<b>51</b>	<b>1</b>	<b>1</b>	<b>A</b>	<b>610</b>	<b>2</b>	<b>1</b>	<b>XX</b>	<b>R</b>	<b>TR</b>

<b>51</b> = 0,51" Digit Dimension	<b>1</b> = Single Digit	<b>1</b> = Model Number 1	<b>A</b> = Commun Anode
-----------------------------------	-------------------------	---------------------------	-------------------------

<b>2</b> = Gray Surface	<b>1</b> = White Diffused	<b>XX</b> = No function	<b>R</b> = ROHS conform <b>N</b> = NON ROHS conform	<b>TR</b> = Tape Reel Packing
-------------------------	---------------------------	-------------------------	--	-------------------------------

**SMT Segment Display Digit Height 13,00mm**

Part No.: **M21D1005**

DRW:	Jason	CHKD	Wilson	MATL:	Wilson	TOLERANCE	Mason	DATE	30.09.2010
APPD:	Schumi			FINISH	Jamy		Sheet No.	6 from 7	Customer:



The Power of LED Light



Soldering Profile Curve

Classification Reflow Profile (JEDEC J-STD-020C)



**SMT Segment Display Digit  
Height 13,00mm**

Part No.: **M21D1005**

Customer:

DRW:	Jason	CHKD	Wilson	MATL:	Wilson	TOLERANCE	Mason	DATE	30.09.2010
APPD:	Schumi			FINISH	Jamy		Sheet No.	7 from 7	