

# EDCON-COMPONENTS



The Power of LED Light



## Dimensions / Informations

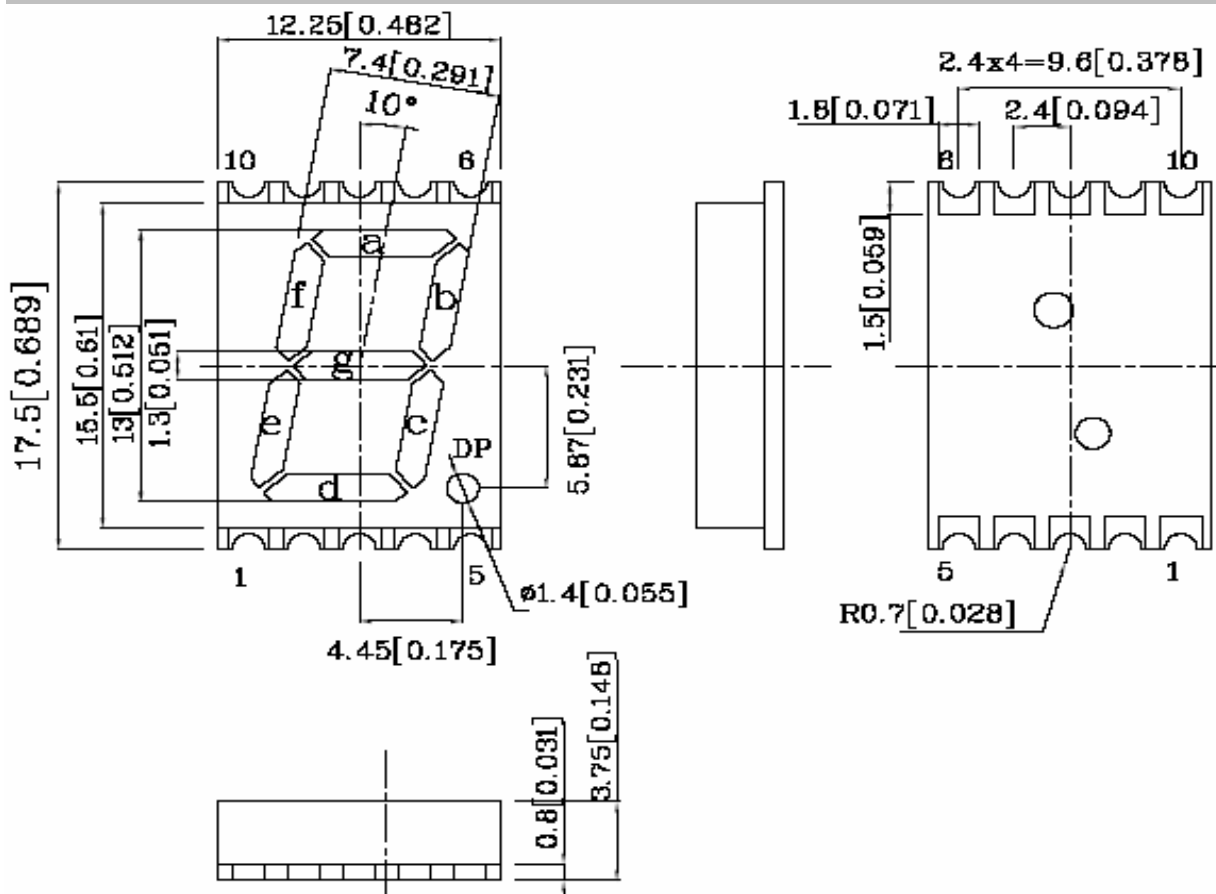

## Features

- Low Current Operation
- Excellent Character appearance
- Easy mounting on P.C. Board or Sockets
- Standard High Brightness
- Mechanical Rugged
- Gray Face / White Segment
- Moisture Sensitivity Level: Level 4

## Diode Drive Construction

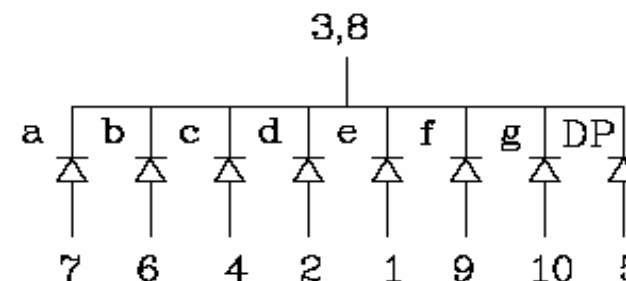

All Dimensions are in millimeters (inches).  
Tolerance is +/- 0,25 (0,01") unless otherwise specified.  
Specifications are subject to change without notice.

**SMT Segment Display Digit  
Height 13,00mm**

Part No.: **M21D1002**

|       |        |      |        |        |        |           |           |          |            |           |
|-------|--------|------|--------|--------|--------|-----------|-----------|----------|------------|-----------|
| DRW:  | Jason  | CHKD | Wilson | MATL:  | Wilson | TOLERANCE | Mason     | DATE     | 30.09.2010 | Customer: |
| APPD: | Schumi |      |        | FINISH | Jamy   |           | Sheet No. | 1 from 7 |            |           |

[www.edcon-components.com](http://www.edcon-components.com)

email: [info@edcon-components.com](mailto:info@edcon-components.com)

# EDCON-COMPONENTS



The Power of LED Light



## Tape specifications

## P.C.B. Layout

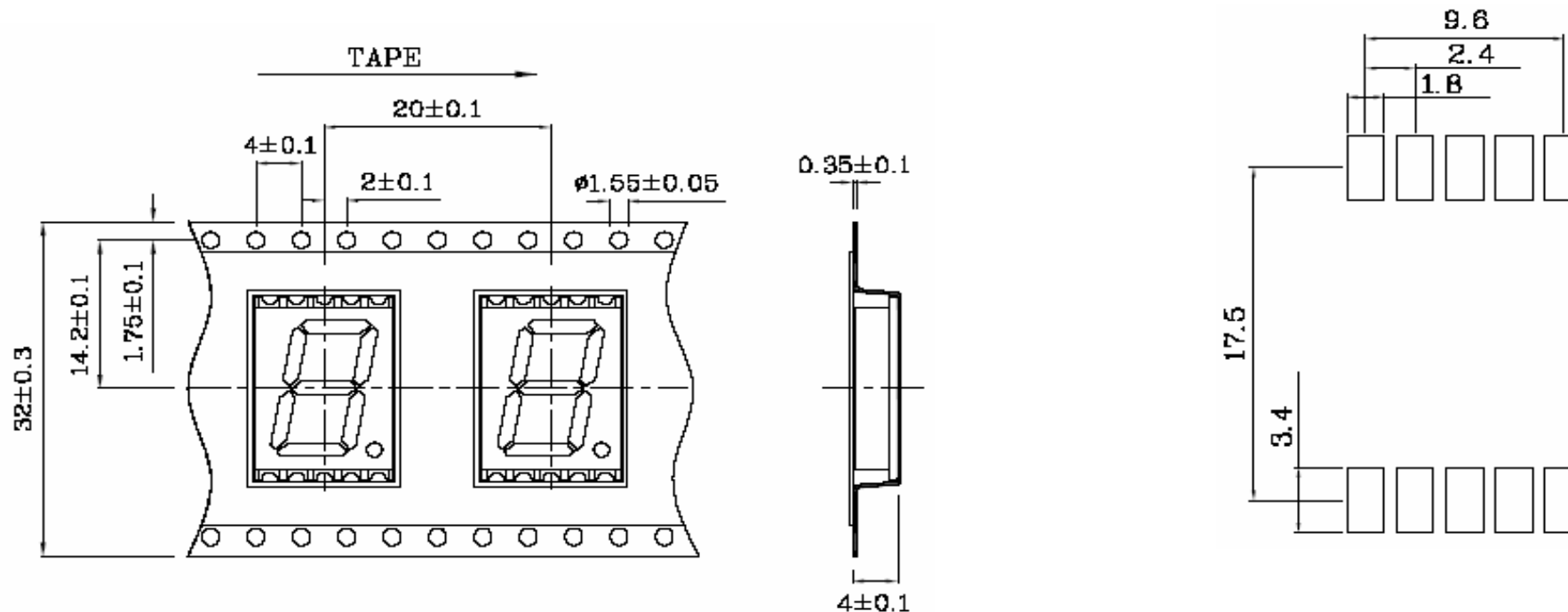

**SMT Segment Display Digit  
Height 13,00mm**

Part No.: **M21D1002**

|       |        |      |        |        |        |           |           |          |            |
|-------|--------|------|--------|--------|--------|-----------|-----------|----------|------------|
| DRW:  | Jason  | CHKD | Wilson | MATL:  | Wilson | TOLERANCE | Mason     | DATE     | 30.09.2010 |
| APPD: | Schumi |      |        | FINISH | Jamy   |           | Sheet No. | 2 from 7 |            |

Customer:

# EDCON-COMPONENTS



The Power of LED Light



## Description

| Part Number | Emitting Color | Emitting Material | Luminous Intensity<br>IF=10mA $\mu$ cd |      | Wavelength nm | Description                             |
|-------------|----------------|-------------------|--|------|---------------|---|
|             |                |                   | min                                    | max, |               |   |
| M21D1002    | Red            | GaAsP/GaP         | 1200                                   | 4290 | 627           | Commun Cathode Right Hand Decimal Point |

| Operating Characteristics<br>(TA=25°C)                     |          | GaAsP/GaP | Unit    |
|--|----------|-----------|---------|
| Forward Voltage (typ).<br>(IF=10mA)                        | VF       | 1,9       | V       |
| Forward Voltage (typ).<br>(IF=10mA)                        | VF       | 2,5       | V       |
| Reverse Current (Max.)<br>(Vr=5V)                          | IR       | 10        | $\mu$ A |
| Wavelength of Peak<br>Emission (typ. If=10mA)              | P        | 627       | nm      |
| Wavelength / Dominant<br>Emission (typ. If=10mA)           | D        | 625       | nm      |
| Spectral Line Full Width<br>at Half-Maximum (typ.<br>10mA) | $\Delta$ | 45        | nm      |
| Capacitance (typ) (Vf=0V,<br>f=1Mhz)                       | C        | 15        | pF      |

| Absolute Maximum Ratings<br>(TA=25°C)                         |      | GaAsP/GaP | Unit |
|---|------|-----------|------|
| Reverse Voltage   | VF   | 5         | V    |
| Forward Current   | IF   | 30        | mA   |
| Forward Current (peak)<br>1/10Duty Cycle 0,1ms<br>Pulse Width | iFS  | 160       | mA   |
| Power Dissipation   | PT   | 75        | mW   |
| Operating Temperature   | TA   | -.40 ~+85 | °C   |
| Storage Temperature   | Tstg | -.40 ~+85 |      |

**SMT Segment Display Digit  
Height 13,00mm**

Part No.: **M21D1002**

|       |        |      |        |        |        |           |           |          |            |           |
|-------|--------|------|--------|--------|--------|-----------|-----------|----------|------------|-----------|
| DRW:  | Jason  | CHKD | Wilson | MATL:  | Wilson | TOLERANCE | Mason     | DATE     | 30.09.2010 | Customer: |
| APPD: | Schumi |      |        | FINISH | Jamy   |           | Sheet No. | 3 from 7 |            |           |

# EDCON-COMPONENTS



The Power of LED Light



## Characteristics

UR

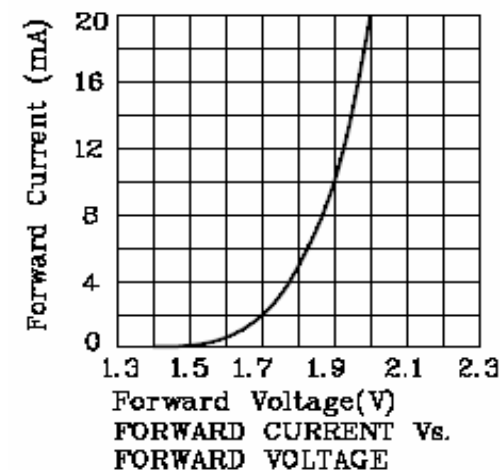
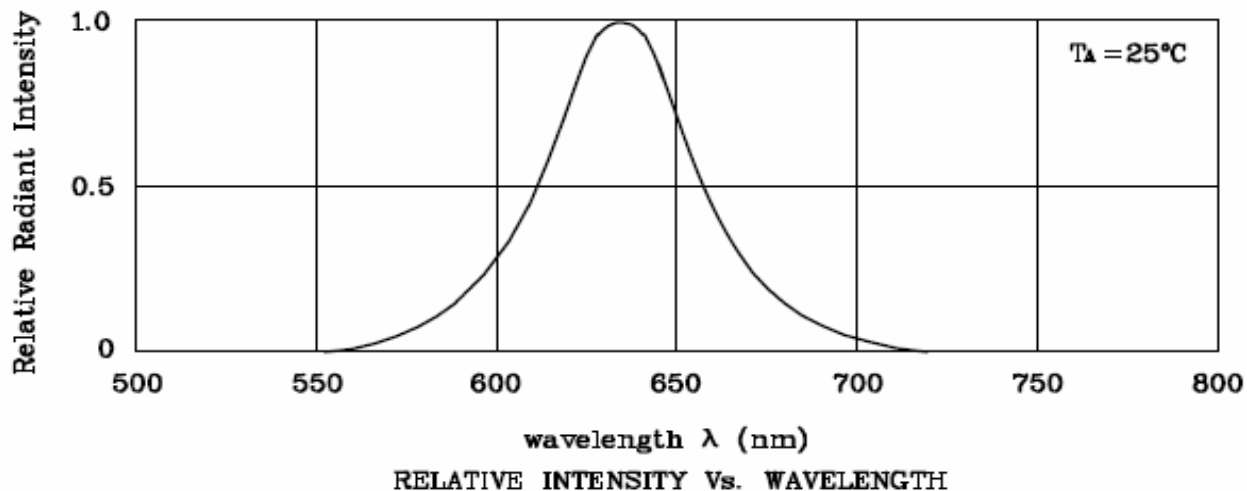

**SMT Segment Display Digit  
Height 13,00mm**

Part No.: **M21D1002**

|       |        |      |        |        |        |           |           |          |            |           |
|-------|--------|------|--------|--------|--------|-----------|-----------|----------|------------|-----------|
| DRW:  | Jason  | CHKD | Wilson | MATL:  | Wilson | TOLERANCE | Mason     | DATE     | 30.09.2010 | Customer: |
| APPD: | Schumi |      |        | FINISH | Jamy   |           | Sheet No. | 4 from 7 |            |           |

# EDCON-COMPONENTS



The Power of LED Light



## Characteristics

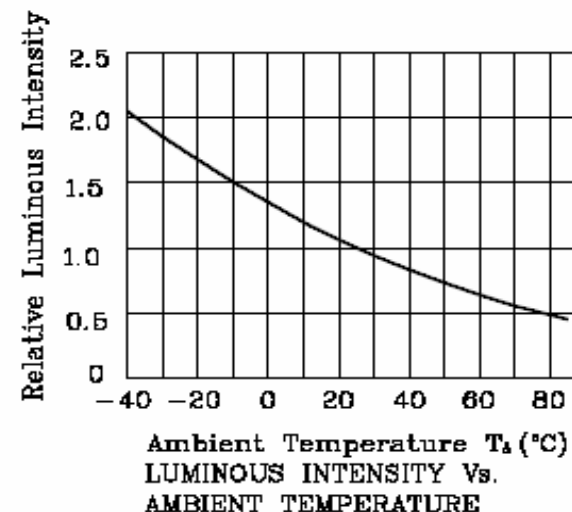
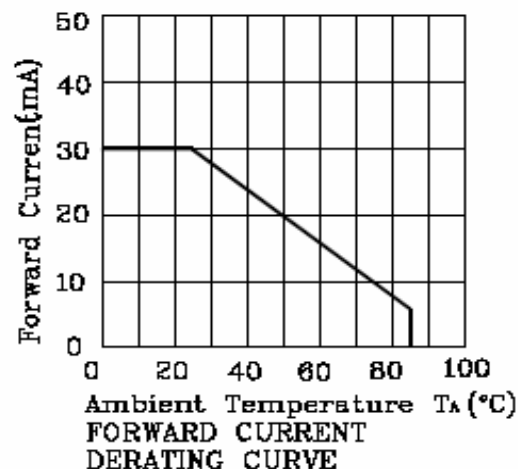
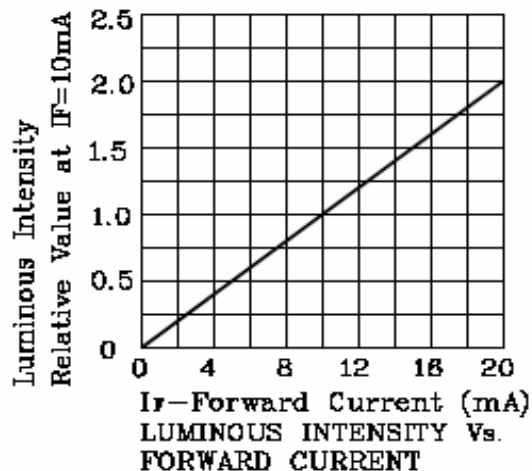

If special sorting is required (e.g. binning based on forward voltage, Luminous intensity /luminous flux, or wavelength).

the typical accuracy of the sorting process is as follows.

Wavelength: +/-1nm

Luminous Intensity / Luminous Flux: +/- 15%

Forward Voltage: +/-0,1V

Note: Accuracy may depend on the sorting parameters.

**SMT Segment Display Digit  
Height 13,00mm**

Part No.: **M21D1002**

Customer:

|       |        |      |        |        |        |           |           |          |            |
|-------|--------|------|--------|--------|--------|-----------|-----------|----------|------------|
| DRW:  | Jason  | CHKD | Wilson | MATL:  | Wilson | TOLERANCE | Mason     | DATE     | 30.09.2010 |
| APPD: | Schumi |      |        | FINISH | Jamy   |           | Sheet No. | 5 from 7 |            |

# EDCON-COMPONENTS



The Power of LED Light



## Ordering Informations

| Serie           | Digit Height Code | Quantity of Digits | Model Number | Diode Drive Code | Emitting Color (nm) | Surface Color Code | Segment Color Code | No Function | ROHS     | Package   |
|-----------------|-------------------|--------------------|--------------|------------------|---------------------|--------------------|--------------------|-------------|----------|-----------|
| <b>M21D1002</b> | <b>51</b>         | <b>1</b>           | <b>1</b>     | <b>C</b>         | <b>627</b>          | <b>2</b>           | <b>1</b>           | <b>XX</b>   | <b>R</b> | <b>TR</b> |

|                                   |                         |                           |                           |
|-----------------------------------|-------------------------|---------------------------|---------------------------|
| <b>51</b> = 0,51" Digit Dimension | <b>1</b> = Single Digit | <b>1</b> = Model Number 1 |                           |
|                                   |                         |                           | <b>C</b> = Commun Cathode |

|                         |                           |                         |  |                               |
|-------------------------|---------------------------|-------------------------|--|-------------------------------|
| <b>2</b> = Gray Surface | <b>1</b> = White Diffused | <b>XX</b> = No function | <b>R</b> = ROHS conform<br><b>N</b> = NON ROHS conform | <b>TR</b> = Tape Reel Packing |
|-------------------------|---------------------------|-------------------------|--|-------------------------------|

**SMT Segment Display Digit Height 13,00mm**

Part No.: **M21D1002**

|       |        |      |        |        |        |           |           |          |            |           |
|-------|--------|------|--------|--------|--------|-----------|-----------|----------|------------|-----------|
| DRW:  | Jason  | CHKD | Wilson | MATL:  | Wilson | TOLERANCE | Mason     | DATE     | 30.09.2010 | Customer: |
| APPD: | Schumi |      |        | FINISH | Jamy   |           | Sheet No. | 6 from 7 |            |           |



The Power of LED Light



Soldering Profile Curve

Classification Reflow Profile (JEDEC J-STD-020C)

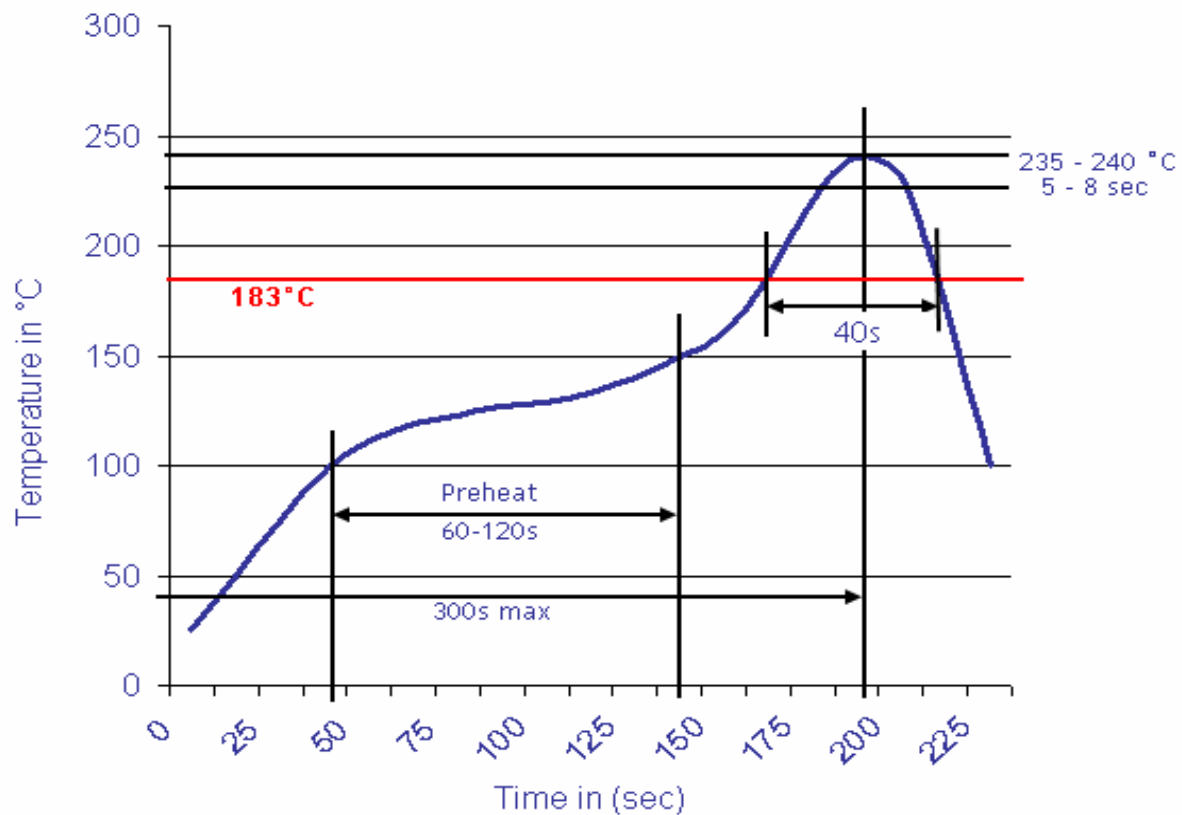

**SMT Segment Display Digit  
Height 13,00mm**

Part No.: **M21D1002**

Customer:

|       |        |      |        |        |        |           |           |          |            |
|-------|--------|------|--------|--------|--------|-----------|-----------|----------|------------|
| DRW:  | Jason  | CHKD | Wilson | MATL:  | Wilson | TOLERANCE | Mason     | DATE     | 30.09.2010 |
| APPD: | Schumi |      |        | FINISH | Jamy   |           | Sheet No. | 7 from 7 |            |