

EDCON-COMPONENTS



The Power of LED Light



Tape Specifications

P.C.B. Layout

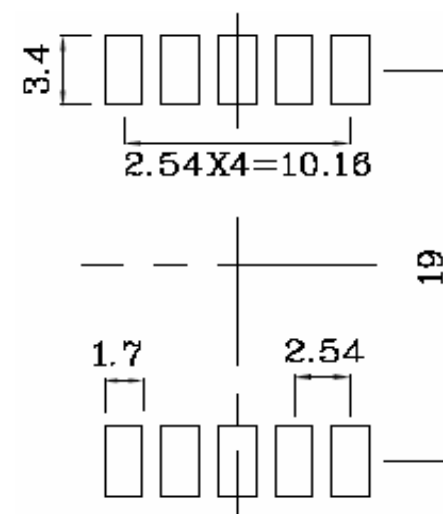
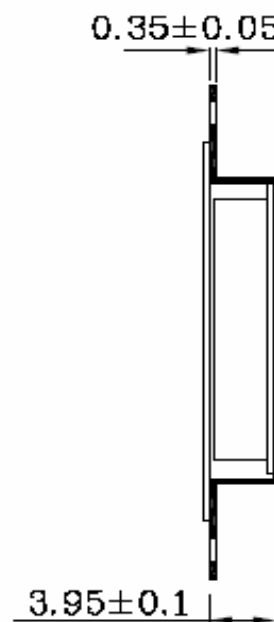
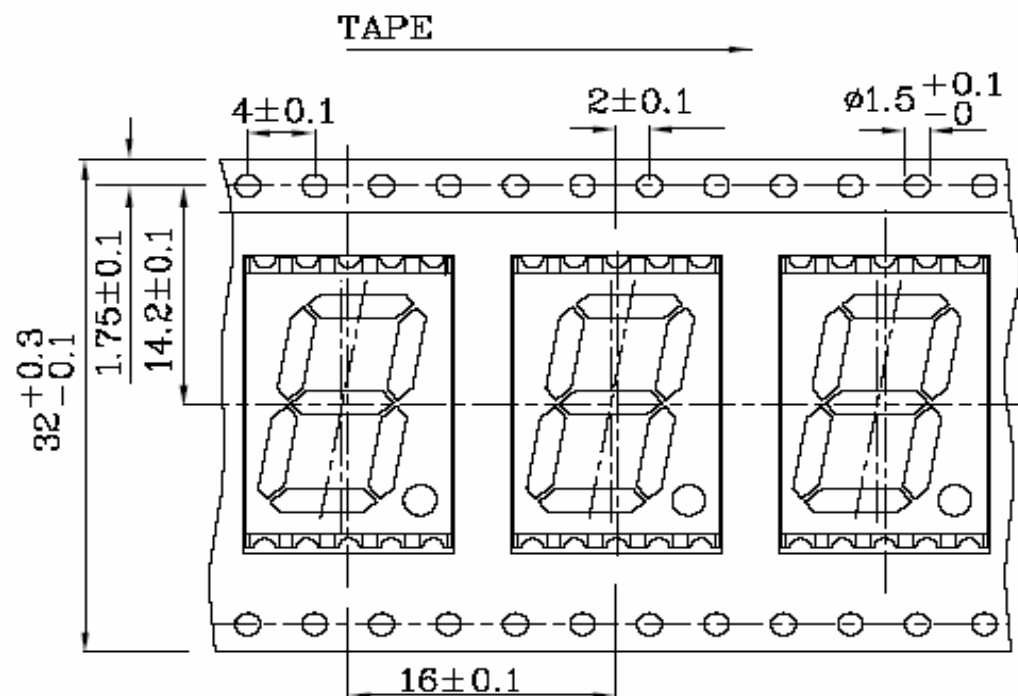

**SMT Segment Display Digit
Height 14,22mm**

Part No.: **M21C7004**

Customer:

| | | | | | | | | | |
|-------|--------|------|--------|--------|--------|-----------|-----------|----------|------------|
| DRW: | Jason | CHKD | Wilson | MATL: | Wilson | TOLERANCE | Mason | DATE | 30.09.2010 |
| APPD: | Schumi | | | FINISH | Jamy | | Sheet No. | 2 from 7 | |

EDCON-COMPONENTS



The Power of LED Light



Description

| Part Number | Emitting Color | Emitting Material | Luminous Intensity IF=10mA μ cd | | Wavelength nm | Description |
|-------------|----------------|-------------------|--|-------|---------------|---|
| | | | min | max, | | |
| M21C7004 | Red | InGaAlP | 4700 | 29990 | 650 | Commun Cathode Right Hand Decimal Point |

| Operating Characteristics (TA=25°C) | | InGaAlP | Unit |
|--|----------|---------|---------|
| Forward Voltage (typ). (IF=10mA) | VF | 1,85 | V |
| Forward Voltage (typ). (IF=10mA) | VF | 2,5 | V |
| Reverse Current (Max.) (Vr=5V) | IR | 10 | μ A |
| Wavelength of Peak Emission (typ. If=10mA) | P | 650 | nm |
| Wavelength / Dominant Emission (typ. If=10mA) | D | 635 | nm |
| Spectral Line Full Width at Half-Maximum (typ. 10mA) | Δ | 28 | nm |
| Capacitance (typ) (Vf=0V, f=1Mhz) | C | 35 | pF |

| Absolute Maximum Ratings (TA=25°C) | | InGaAlP | Unit |
|---|------|-----------|------|
| Reverse Voltage | VF | 5 | V |
| Forward Current | IF | 30 | mA |
| Forward Current (peak) 1/10Duty Cycle 0,1ms Pulse Width | iFS | 185 | mA |
| Power Dissipation | PT | 75 | mW |
| Operating Temperature | TA | -.40 ~+85 | °C |
| Storage Temperature | Tstg | -.40 ~+85 | |

**SMT Segment Display Digit
Height 14,22mm**

Part No.: **M21C7004**

| | | | | | | | | | | |
|-------|--------|------|--------|--------|--------|-----------|-----------|----------|------------|-----------|
| DRW: | Jason | CHKD | Wilson | MATL: | Wilson | TOLERANCE | Mason | DATE | 30.09.2010 | Customer: |
| APPD: | Schumi | | | FINISH | Jamy | | Sheet No. | 3 from 7 | | |



The Power of LED Light



Characteristics

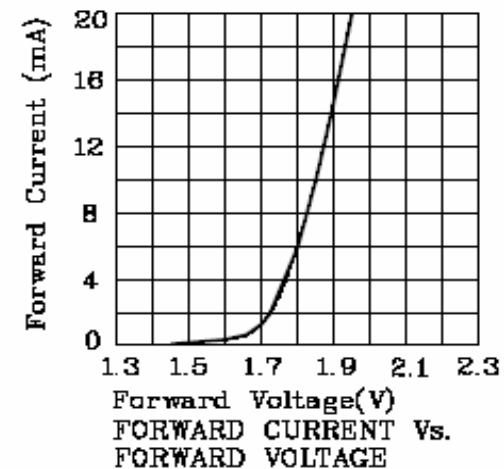
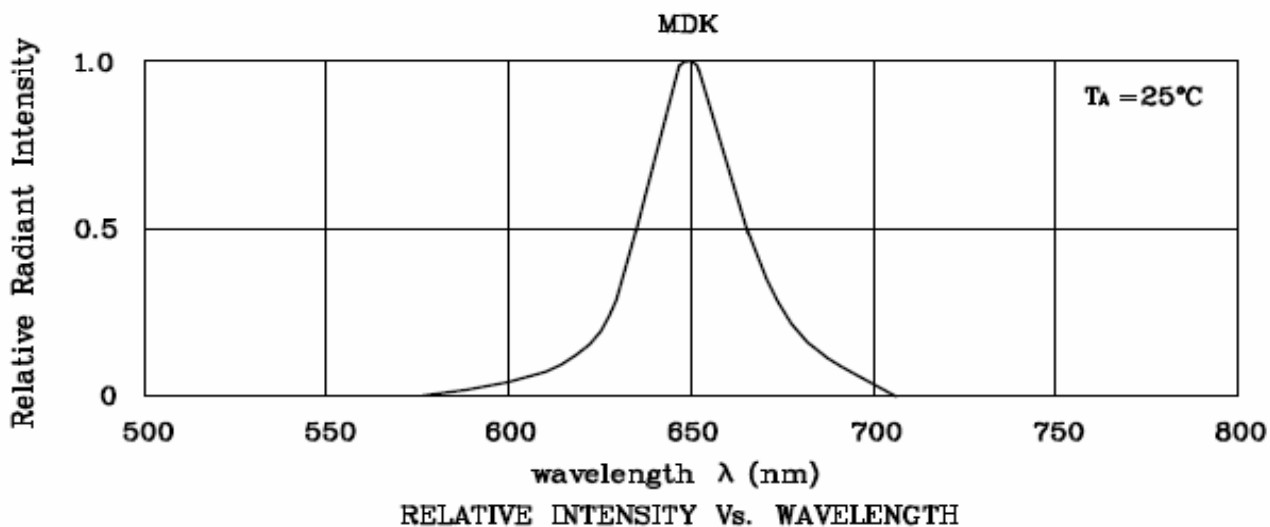

**SMT Segment Display Digit
 Height 14,22mm**

Part No.: **M21C7004**

| | | | | | | | | | |
|-------|--------|------|--------|--------|--------|-----------|-----------|----------|------------|
| DRW: | Jason | CHKD | Wilson | MATL: | Wilson | TOLERANCE | Mason | DATE | 30.09.2010 |
| APPD: | Schumi | | | FINISH | Jamy | | Sheet No. | 4 from 7 | Customer: |

EDCON-COMPONENTS



The Power of LED Light



Characteristics

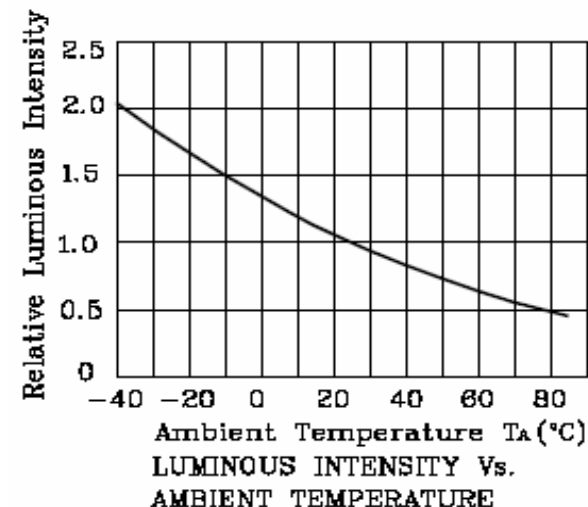
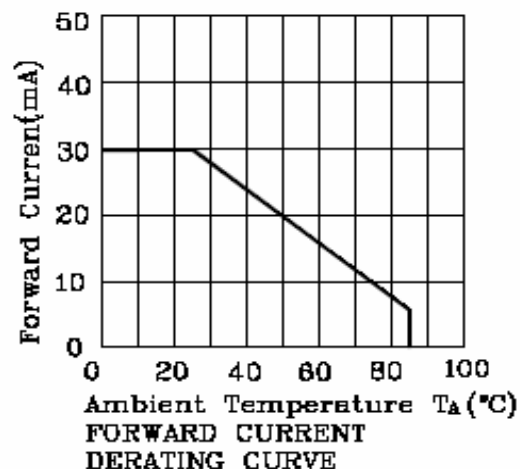
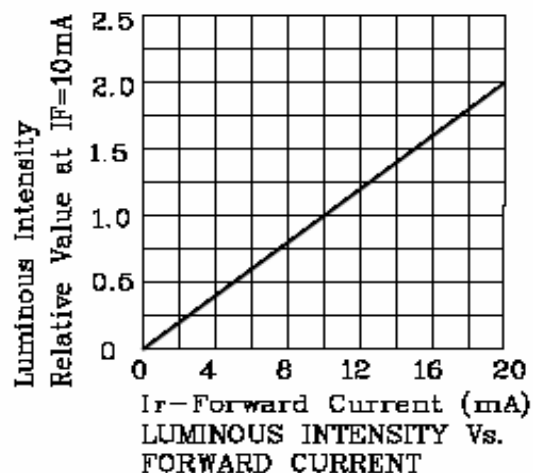

If special sorting is required (e.g. binning based on forward voltage, Luminous intensity /luminous flux, or wavelength).

the typical accuracy of the sorting process is as follows.

Wavelength: +/-1nm

Luminous Intensity / Luminous Flux: +/- 15%

Forward Voltage: +/-0,1V

Note: Accuracy may depend on the sorting parameters.

**SMT Segment Display Digit
Height 14,22mm**

Part No.: **M21C7004**

Customer:

| | | | | | | | | | |
|-------|--------|------|--------|--------|--------|-----------|-----------|----------|------------|
| DRW: | Jason | CHKD | Wilson | MATL: | Wilson | TOLERANCE | Mason | DATE | 30.09.2010 |
| APPD: | Schumi | | | FINISH | Jamy | | Sheet No. | 5 from 7 | |

EDCON-COMPONENTS



The Power of LED Light



Ordering Informations

| Serie | Digit Height Code | Quantity of Digits | Model Number | Diode Drive Code | Emitting Color (nm) | Surface Color Code | Segment Color Code | No Function | ROHS | Package |
|-----------------|-------------------|--------------------|--------------|------------------|---------------------|--------------------|--------------------|-------------|----------|-----------|
| M21C7004 | 56 | 1 | 1 | C | 650 | 2 | 1 | XX | R | TR |

| | | | |
|--|---------------------------|-----------------------------|-----------------------------|
| 56= 0,56" Digit Dimension | 1= Single Digit | 1= Model Number 1 | |
| | | | C= Commun Cathode |

| | | | | |
|---------------------------|-----------------------------|---------------------------|---|---------------------------------|
| 2= Gray Surface | 1= White Diffused | XX= No function | R= ROHS conform N= NON ROHS conform | TR= Tape Reel Packing |
|---------------------------|-----------------------------|---------------------------|---|---------------------------------|

**SMT Segment Display Digit
Height 14,22mm**

Part No.: **M21C7004**

| | | | | | | | | | |
|-------|--------|------|--------|--------|--------|-----------|-----------|------|------------|
| DRW: | Jason | CHKD | Wilson | MATL: | Wilson | TOLERANCE | Mason | DATE | 30.09.2010 |
| APPD: | Schumi | | | FINISH | Jamy | | Sheet No. | | 6 from 7 |

Customer:



The Power of LED Light



Soldering Profile Curve

Classification Reflow Profile (JEDEC J-STD-020C)



**SMT Segment Display Digit
Height 14,22mm**

Part No.: **M21C7004**

Customer:

| | | | | | | | | | |
|-------|--------|------|--------|--------|--------|-----------|-----------|----------|------------|
| DRW: | Jason | CHKD | Wilson | MATL: | Wilson | TOLERANCE | Mason | DATE | 30.09.2010 |
| APPD: | Schumi | | | FINISH | Jamy | | Sheet No. | 7 from 7 | |