

# EDCON-COMPONENTS



The Power of LED Light



## Dimensions / Informations

## Features

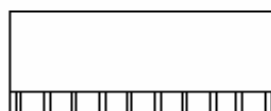
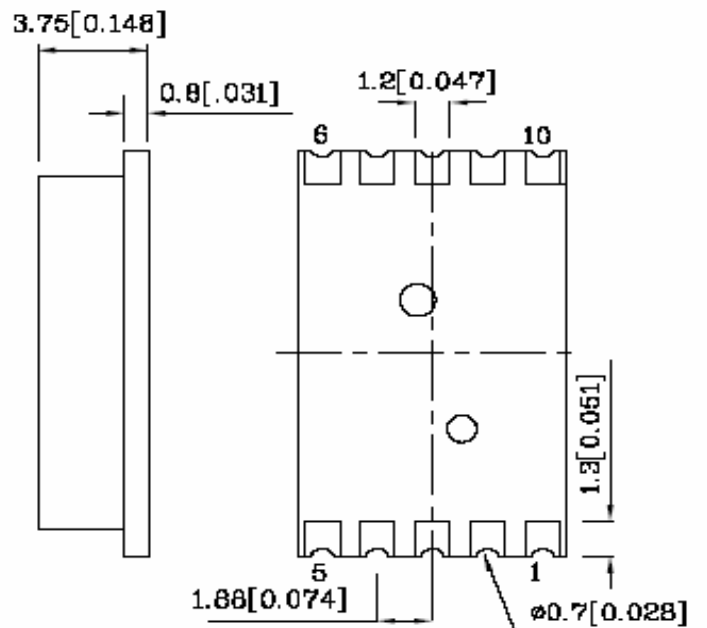

- Low Current Operation
  - Excellent Character appearance
  - Easy mounting on P.C. Board or Sockets
  - Standard High Brightness
  - Mechanical Rugged
  - Gray Face / White Segment
  - Moisture Sensitivity Level: Level 4
- All Dimensions are in millimeters (inches).  
Tolerance is +/- 0,25 (0,01") unless otherwise specified.  
Specifications are subject to change without notice.

## Diode Drive Construction

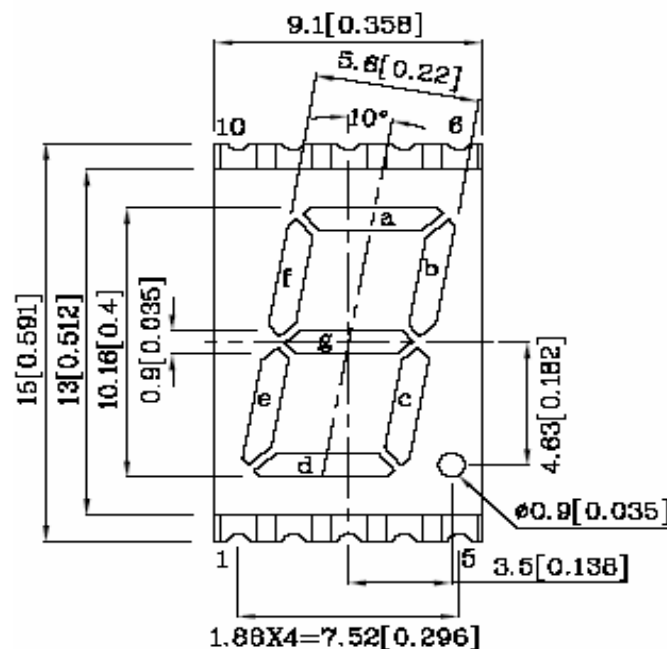
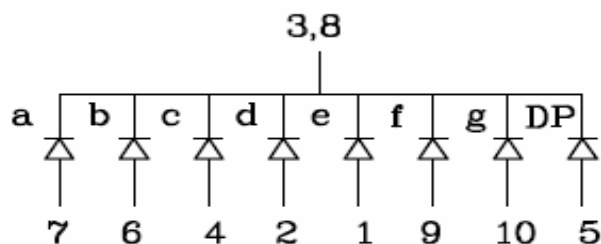

**SMT Segment Display Digit  
Height 10,16mm**

Part No.: **M21C5004**

Customer:

DRW:	Jason	CHKD	Wilson	MATL:	Wilson	TOLERANCE	Mason	DATE	30.09.2010
APPD:	Schumi			FINISH	Jamy		Sheet No.		1 from 7

# EDCON-COMPONENTS



The Power of LED Light



## Tape specifications

## P.C.B. Layout

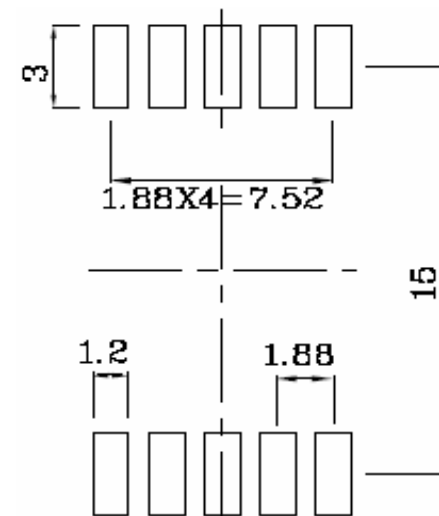
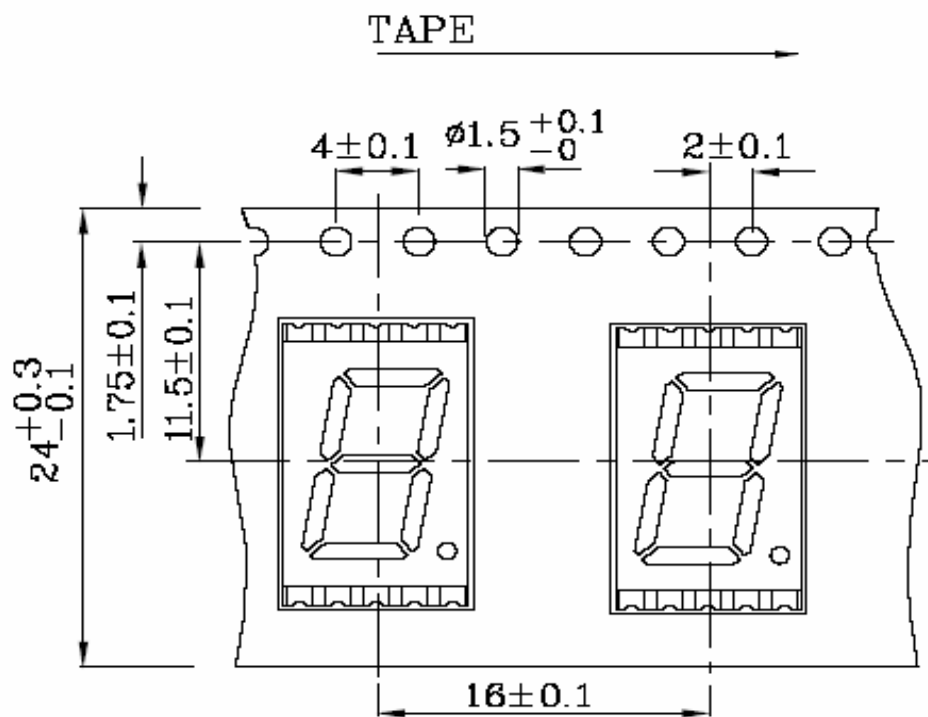

**SMT Segment Display Digit  
Height 10,16mm**

Part No.: **M21C5004**

Customer:

DRW:	Jason	CHKD	Wilson	MATL:	Wilson	TOLERANCE	Mason	DATE	30.09.2010
APPD:	Schumi			FINISH	Jamy		Sheet No.	2 from 7	

# EDCON-COMPONENTS



The Power of LED Light



## Description

Part Number	Emitting Color	Emitting Material	Luminous Intensity IF=10mA $\mu$ cd		Wavelength nm	Description
			min	max,		
M21C5004	Red	InGaAlP	8000	25990	650	Commun Cathode Right Hand Decimal Point

Operating Characteristics (TA=25°C)		InGaAlP	Unit
Forward Voltage (typ). (IF=10mA)	VF	1,85	V
Forward Voltage (typ). (IF=10mA)	VF	2,5	V
Reverse Current (Max.) (Vr=5V)	IR	10	$\mu$ A
Wavelength of Peak Emission (typ. If=10mA)	P	650	nm
Wavelength / Dominant Emission (typ. If=10mA)	D	635	nm
Spectral Line Full Width at Half-Maximum (typ. 10mA)	$\Delta$	29	nm
Capacitance (typ) (Vf=0V, f=1Mhz)	C	35	pF

Absolute Maximum Ratings (TA=25°C)		InGaAlP	Unit
Reverse Voltage	VF	5	V
Forward Current	IF	30	mA
Forward Current (peak) 1/10Duty Cycle 0,1ms Pulse Width	iFS	185	mA
Power Dissipation	PT	75	mW
Operating Temperature	TA	-.40 ~+85	°C
Storage Temperature	Tstg	-.40 ~+85	

**SMT Segment Display Digit  
Height 10,16mm**

Part No.: **M21C5004**

DRW:	Jason	CHKD	Wilson	MATL:	Wilson	TOLERANCE	Mason	DATE	30.09.2010	Customer:
APPD:	Schumi			FINISH	Jamy		Sheet No.	3 from 7		

# EDCON-COMPONENTS



The Power of LED Light



## Characteristics

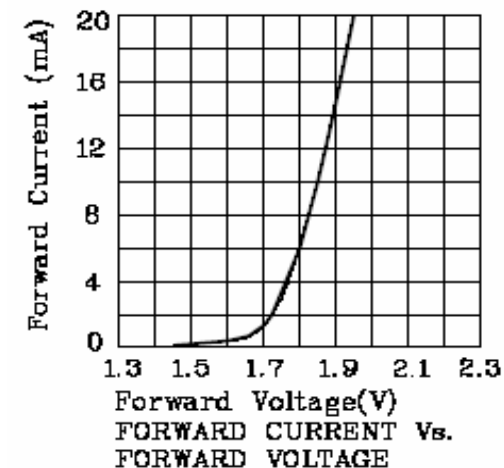
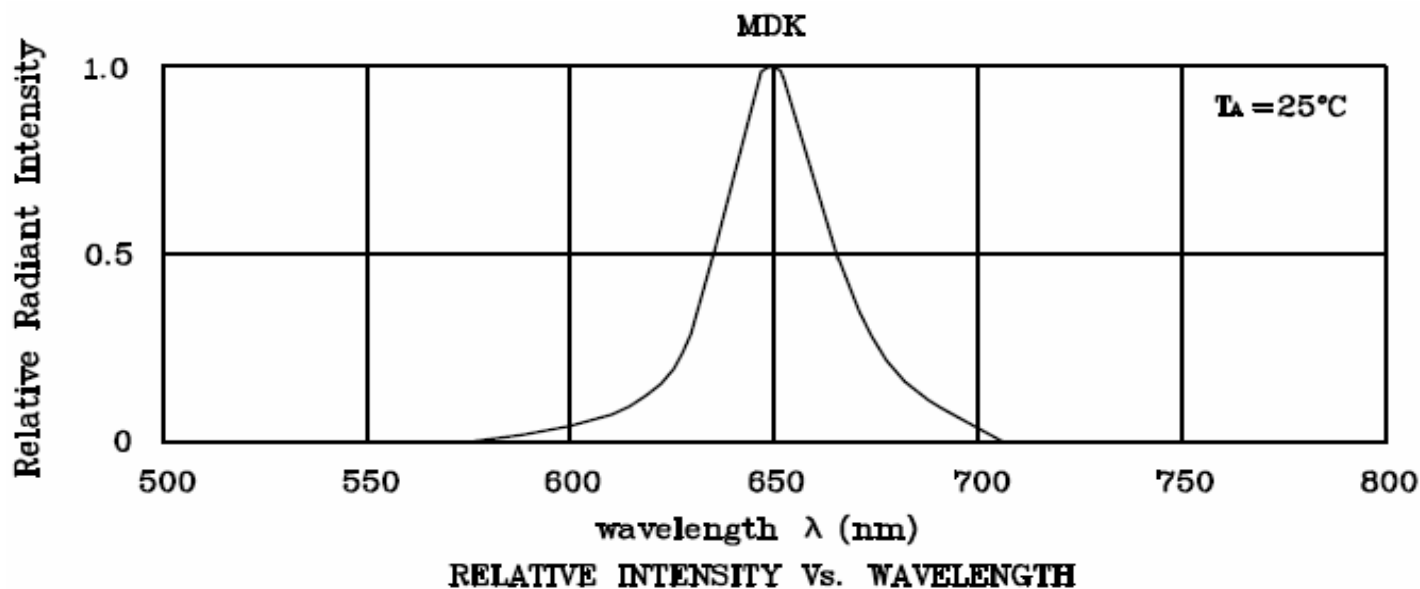

**SMT Segment Display Digit  
Height 10,16mm**

Part No.: **M21C5004**

DRW:	Jason	CHKD	Wilson	MATL:	Wilson	TOLERANCE	Mason	DATE	30.09.2010	Customer:
APPD:	Schumi			FINISH	Jamy		Sheet No.	4 from 7		

# EDCON-COMPONENTS



The Power of LED Light



## Characteristics

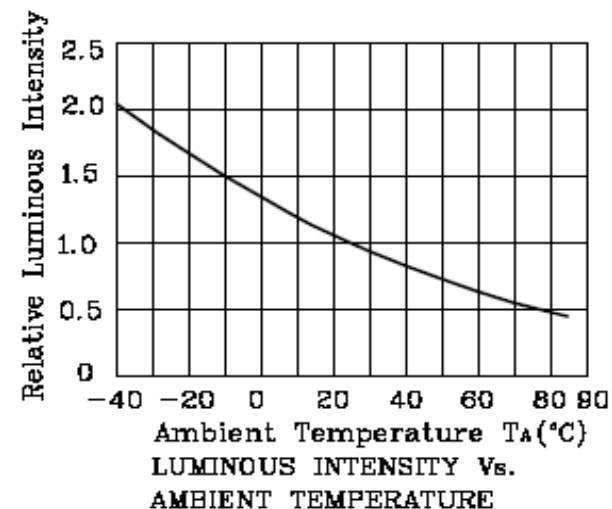
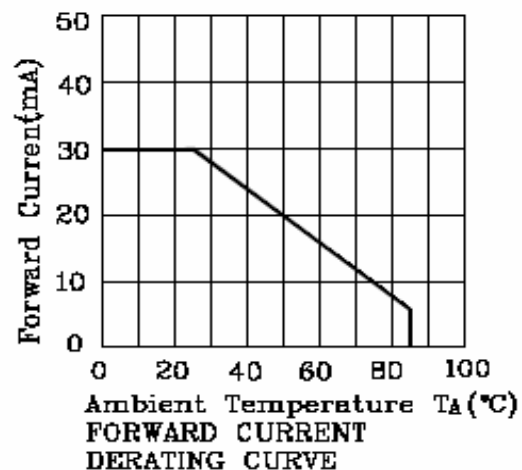
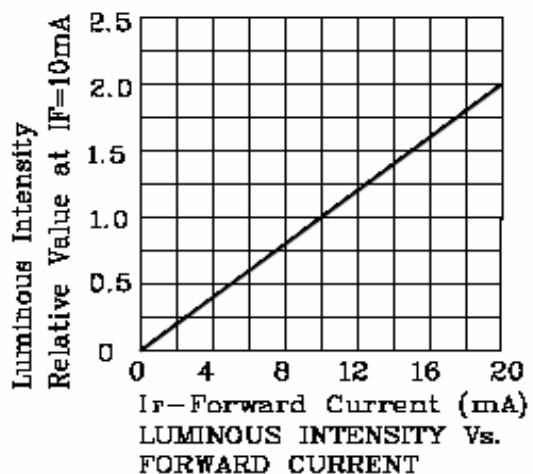

If special sorting is required (e.g. binning based on forward voltage, Luminous intensity /luminous flux, or wavelength).

the typical accuracy of the sorting process is as follows.

Wavelength: +/-1nm

Luminous Intensity / Luminous Flux: +/- 15%

Forward Voltage: +/-0,1V

Note: Accuracy may depend on the sorting parameters.

**SMT Segment Display Digit  
Height 10,16mm**

Part No.: **M21C5004**

Customer:

DRW:	Jason	CHKD	Wilson	MATL:	Wilson	TOLERANCE	Mason	DATE	30.09.2010
APPD:	Schumi			FINISH	Jamy		Sheet No.	5 from 7	

[www.edcon-components.com](http://www.edcon-components.com)

email: [info@edcon-components.com](mailto:info@edcon-components.com)

# EDCON-COMPONENTS



The Power of LED Light



## Ordering Informations

Serie	Digit Height Code	Quantity of Digits	Model Number	Diode Drive Code	Emitting Color (nm)	Surface Color Code	Segment Color Code	No Function	ROHS	Package
<b>M21C5004</b>	<b>40</b>	<b>1</b>	<b>1</b>	<b>C</b>	<b>650</b>	<b>2</b>	<b>1</b>	<b>XX</b>	<b>R</b>	<b>TR</b>

<b>40= 0,40"</b> Digit Dimension	<b>1= Single</b> Digit	<b>1= Model</b> Number 1	<b>C= Commun</b> Cathode
--	---------------------------	-----------------------------	-----------------------------

<b>2= Gray</b> Surface	<b>1= White</b> Diffused	<b>XX= No</b> function	<b>R= ROHS</b> conform <b>N= NON</b> ROHS conform	<b>TR= Tape</b> Reel Packing
---------------------------	-----------------------------	---------------------------	---	---------------------------------

**SMT Segment Display Digit  
Height 10,16mm**

Part No.: **M21C5004**

DRW:	Jason	CHKD	Wilson	MATL:	Wilson	TOLERANCE	Mason	DATE	30.09.2010	Customer:
APPD:	Schumi			FINISH	Jamy		Sheet No.	6 from 7		



The Power of LED Light



Soldering Profile Curve

Classification Reflow Profile (JEDEC J-STD-020C)

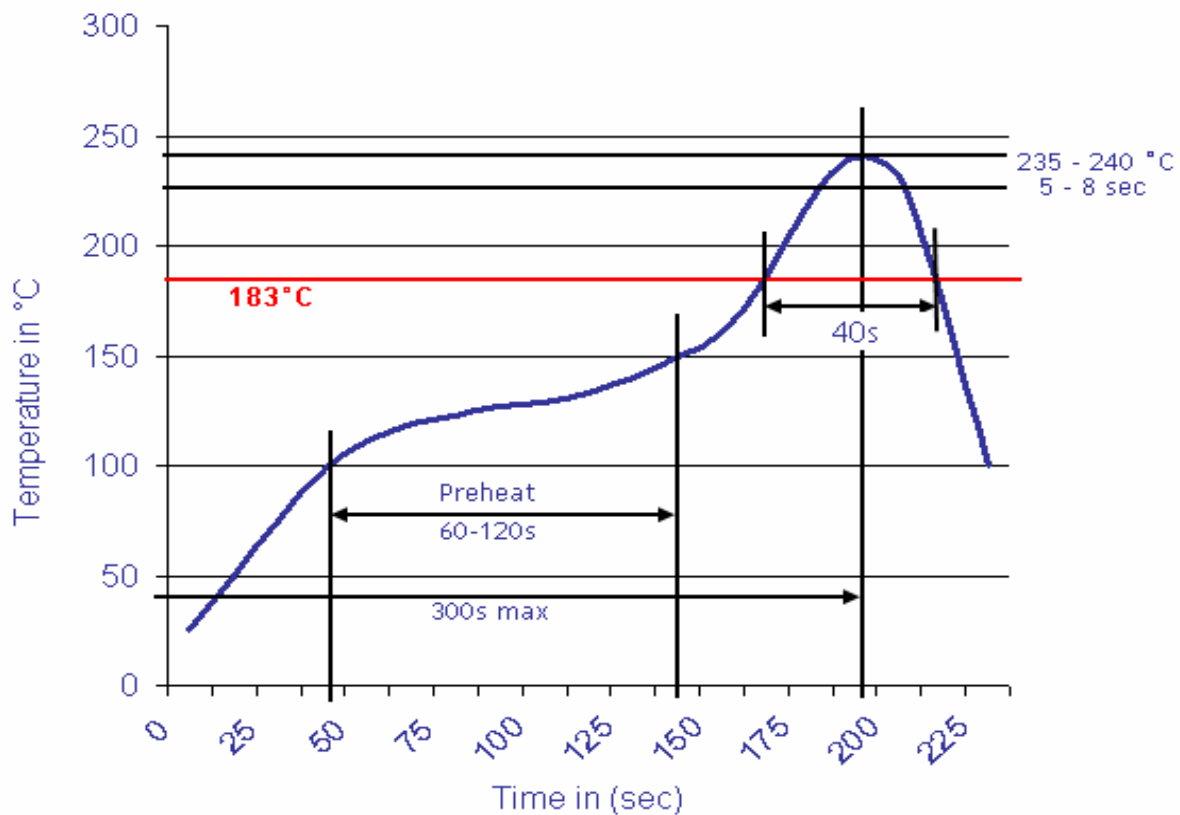

**SMT Segment Display Digit  
Height 10,16mm**

Part No.: **M21C5004**

DRW:	Jason	CHKD	Wilson	MATL:	Wilson	TOLERANCE	Mason	DATE	30.09.2010
APPD:	Schumi			FINISH	Jamy		Sheet No.	7 from 7	Customer: