

EDCON-COMPONENTS



The Power of LED Light



Dimensions / Informations

Features

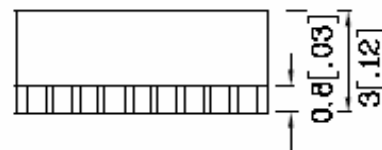
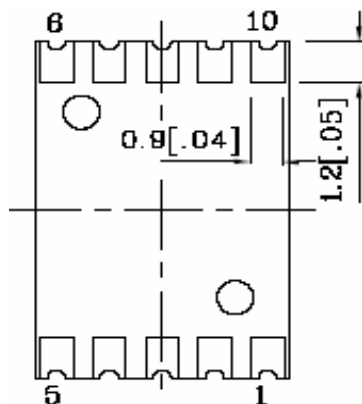
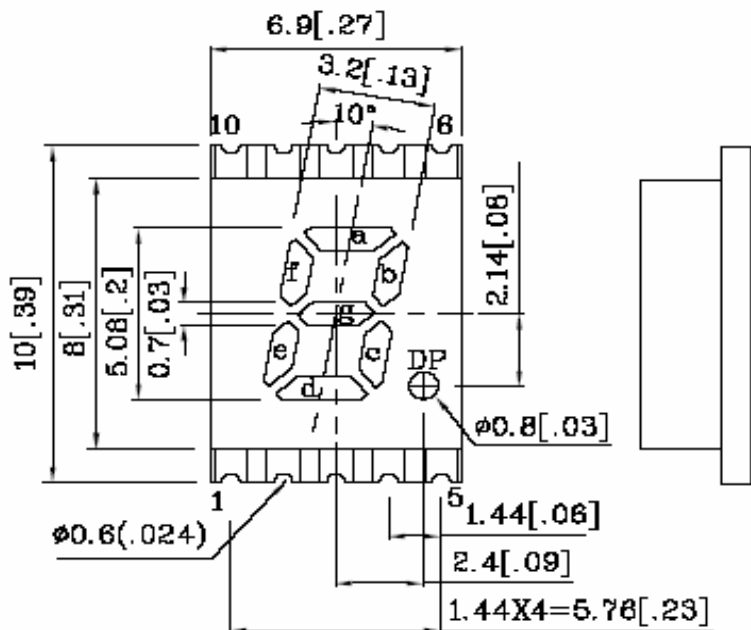

- Low Current Operation
- Excellent Character appearance
- Easy mounting on P.C. Board or Sockets
- Standard High Brightness
- Mechanical Rugged
- Gray Face / White Segment
- Moisture Sensitivity Level: Level 4

Diode Drive Construction

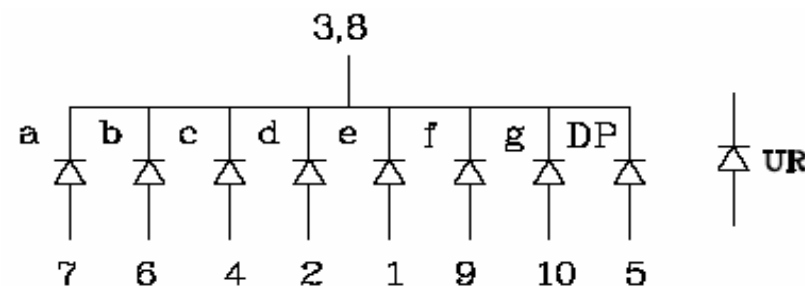

All Dimensions are in millimeters (inches).
Tolerance is +/- 0,25 (0,01") unless otherwise specified.
Specifications are subject to change without notice.

**SMT Segment Display Digit
Height 7,62mm**

Part No.: **M21C3004**

DRW:	Jason	CHKD	Wilson	MATL:	Wilson	TOLERANCE	Mason	DATE	30.09.2010	Customer:
APPD:	Schumi			FINISH	Jamy		Sheet No.	1 from 7		

www.edcon-components.com

email: info@edcon-components.com

EDCON-COMPONENTS



The Power of LED Light



Tape specifications

P.C.B. Layout

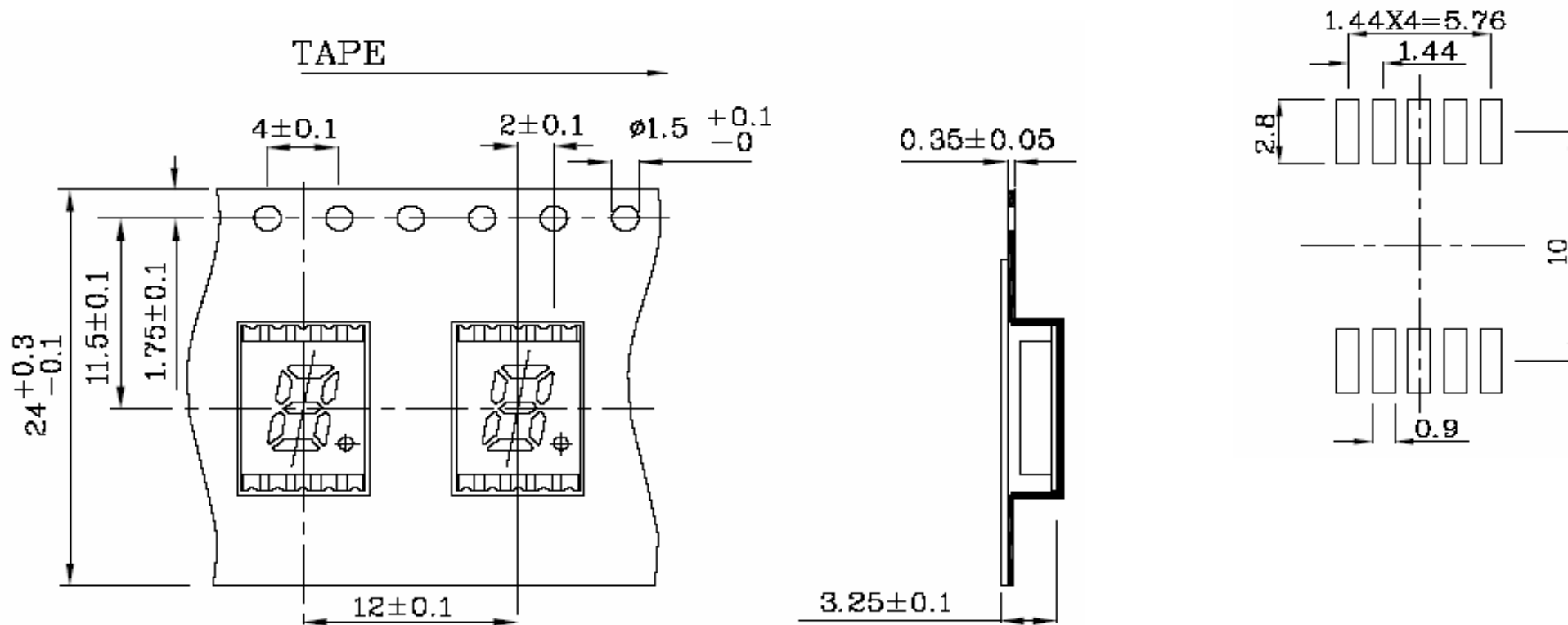

**SMT Segment Display Digit
Height 7,62mm**

Part No.: **M21C3004**

Customer:

DRW:	Jason	CHKD	Wilson	MATL:	Wilson	TOLERANCE	Mason	DATE	30.09.2010
APPD:	Schumi			FINISH	Jamy		Sheet No.	2 from 7	

EDCON-COMPONENTS



The Power of LED Light



Description

Part Number	Emitting Color	Emitting Material	Luminous Intensity IF=10mA μ cd		Wavelength nm	Description
			min	max,		
M21C3004	Red	InGaAlP	8000	26990	650	Commun Cathode Right Hand Decimal Point

Operating Characteristics (TA=25°C)		InGaAlP	Unit
Forward Voltage (typ). (IF=10mA)	VF	1,85	V
Forward Voltage (typ). (IF=10mA)	VF	2,5	V
Reverse Current (Max.) (Vr=5V)	IR	10	μ A
Wavelength of Peak Emission (typ. If=10mA)	P	650	nm
Wavelength / Dominant Emission (typ. If=10mA)	D	635	nm
Spectral Line Full Width at Half-Maximum (typ. 10mA)	Δ	28	nm
Capacitance (typ) (Vf=0V, f=1Mhz)	C	35	pF

Absolute Maximum Ratings (TA=25°C)		InGaAlP	Unit
Reverse Voltage	VF	5	V
Forward Current	IF	30	mA
Forward Current (peak) 1/10Duty Cycle 0,1ms Pulse Width	iFS	185	mA
Power Dissipation	PT	75	mW
Operating Temperature	TA	-.40 ~+85	°C
Storage Temperature	Tstg	-.40 ~+85	

**SMT Segment Display Digit
Height 7,62mm**

Part No.: **M21C3004**

DRW:	Jason	CHKD	Wilson	MATL:	Wilson	TOLERANCE	Mason	DATE	30.09.2010	Customer:
APPD:	Schumi			FINISH	Jamy		Sheet No.	3 from 7		

EDCON-COMPONENTS



The Power of LED Light



Characteristics

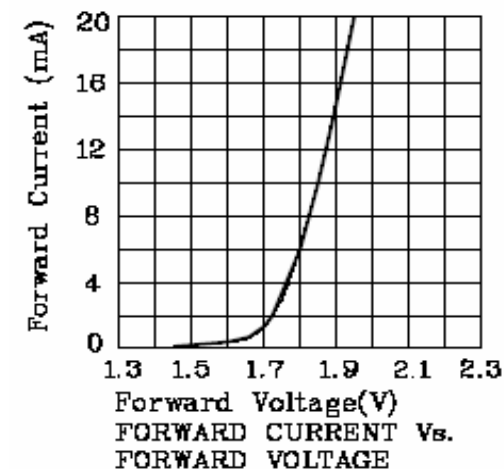
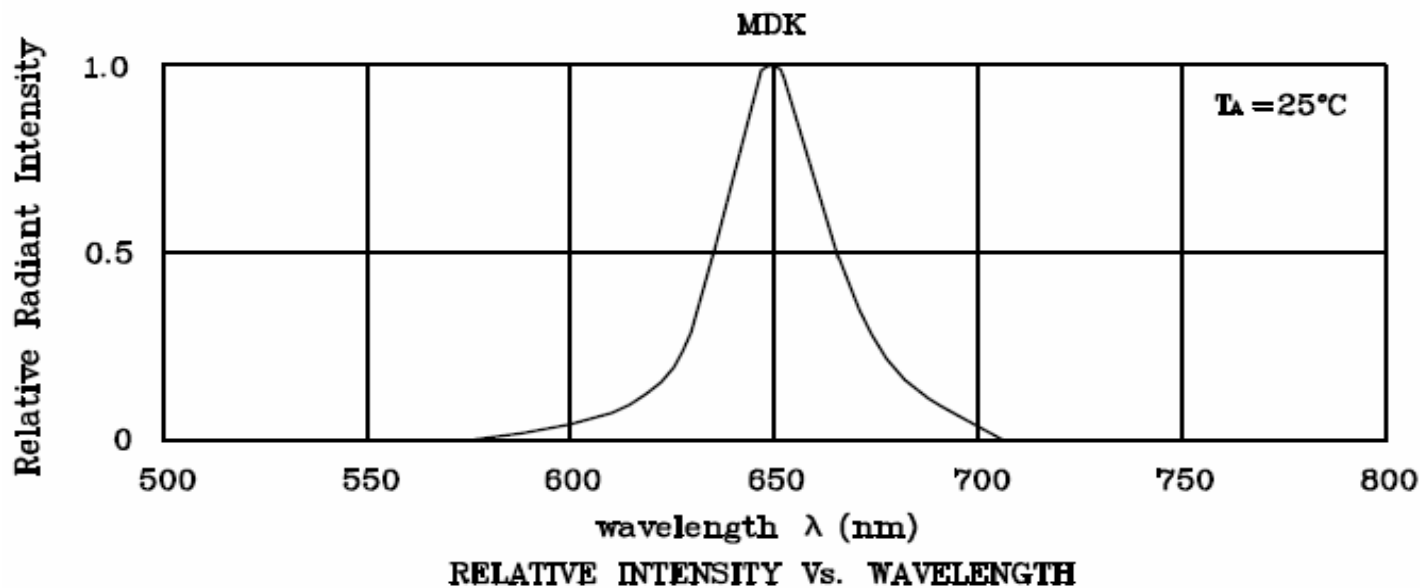

**SMT Segment Display Digit
Height 7,62mm**

Part No.: **M21C3004**

Customer:

DRW:	Jason	CHKD	Wilson	MATL:	Wilson	TOLERANCE	Mason	DATE	30.09.2010
APPD:	Schumi			FINISH	Jamy		Sheet No.	4 from 7	

EDCON-COMPONENTS



The Power of LED Light



Characteristics

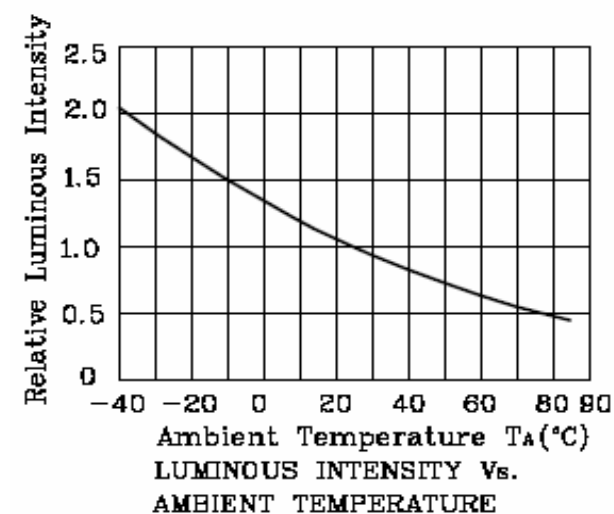
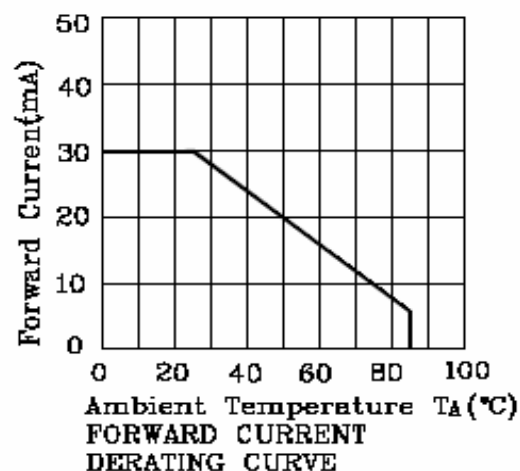
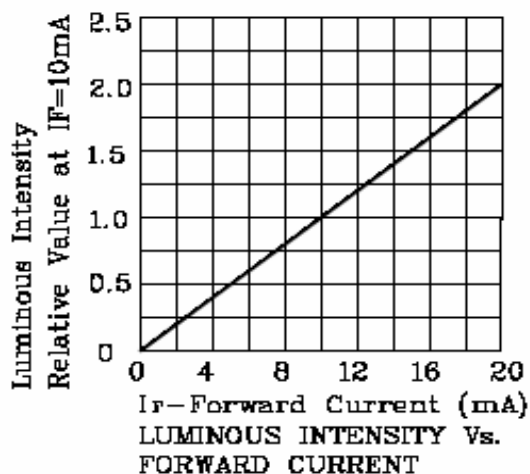

Is special sorting is required (e.g. binning based on forward voltage. Luminous intensity /luminous flux, or wavelength).

the typical accuracy of the sorting process is as follows.

Wavelength: +/-1nm

Luminous Intensity / Luminous Flux: +/- 15%

Forward Voltage: +/-0,1V

Note: Accuracy may depend on the sorting parameters.

**SMT Segment Display Digit
Height 7,62mm**

Part No.: **M21C3004**

Customer:

DRW:	Jason	CHKD	Wilson	MATL:	Wilson	TOLERANCE	Mason	DATE	30.09.2010
APPD:	Schumi			FINISH	Jamy		Sheet No.	5 from 7	

www.edcon-components.com

email: info@edcon-components.com

EDCON-COMPONENTS



The Power of LED Light



Ordering Informations

Serie	Digit Height Code	Quantity of Digits	Model Number	Diode Drive Code	Emitting Color (nm)	Surface Color Code	Segment Color Code	No Function	ROHS	Package
M21C3004	30	1	1	C	650	2	1	XX	R	TR

30= 0,30" Digit Dimension	1= Single Digit	1= Model Number 1	C= Commun Cathode
--	---------------------------	-----------------------------	-----------------------------

2= Gray Surface	1= White Diffused	XX= No function	R= ROHS conform N= NON ROHS conform	TR= Tape Reel Packing
---------------------------	-----------------------------	---------------------------	---	---------------------------------

**SMT Segment Display Digit
Height 7,62mm**

Part No.: **M21C3004**

DRW:	Jason	CHKD	Wilson	MATL:	Wilson	TOLERANCE	Mason	DATE	30.09.2010	Customer:
APPD:	Schumi			FINISH	Jamy		Sheet No.	6 from 7		



The Power of LED Light



Soldering Profile Curve

Classification Reflow Profile (JEDEC J-STD-020C)



**SMT Segment Display Digit
Height 7,62mm**

Part No.: **M21C3004**

DRW:	Jason	CHKD	Wilson	MATL:	Wilson	TOLERANCE	Mason	DATE	30.09.2010	Customer:
APPD:	Schumi			FINISH	Jamy		Sheet No.	7 from 7		