

EDCON-COMPONENTS



Specifications

I17042 Serie is molded Solid tantalum capacitor with Sinterd and polymer as the cathode, featuring low ESR and good frequency resonance, resistance to high ripple current, small size, small weight, high reliability, high reliability and long life I17042 Series is equivalent to Kemet 520 series.

Operating temperature Range $-55^{\circ}\text{C} \sim +125^{\circ}\text{C}$ (85°C with rated voltage derating).

Capacitance tolerance: $\pm 20\%$.

DC leakage, dissipation factor and ESR at 25°C .

Taping and reeling per EIA481-1 Specification.

General purpose surface mount type.

Compact size & wide CV range.

High Solderability & stabler characteristics for soldering.

Compatible with all popular automatic pick and place equipment.

Technical Drawing



Technical	Performance Characteristics
Operating Temperature Range:	$-55^{\circ}\text{C} \sim +125^{\circ}\text{C}$
Rated Working Voltage:	4 to 50VDC
Nominal Capacitance Range:	0,1 to 1500 μF
Capacitance Tolerance:	$\pm 20\%$ / $\pm 10\%$ (120Hz $\pm 20^{\circ}\text{C}$)
Leakage Current:	Not more than 0,01CV (μA) or 0,5 μA whichever is greater

Dimensions

Case Size	L= $\pm 0,2$	W1= $\pm 7-0,2$	H= $\pm 0,2$	S= $\pm 0,2$	W2= $\pm 0,2$
S	2,0	1,2	1,2	0,5	1,2
A	3,2	1,6	1,6	0,8	1,2
B	3,5	2,8	1,9	0,8	2,2
C	6,0	3,2	2,5	1,3	2,2
D	7,3	4,3	2,8	1,3	2,4
E	7,3	4,3	4,0	1,3	2,4
V	7,3	6,1	3,5	1,4	3,1

Characteristics at High and Low Temperature	capacitance (μF)	Capacitance Change (%)			DF Max. (%)				DCL Max. (μF)	
		-55°C	$+85^{\circ}\text{C}$	$+125^{\circ}\text{C}$	-55°C	$+20^{\circ}\text{C}$	$+55^{\circ}\text{C}$	$+125^{\circ}\text{C}$	$+85^{\circ}\text{C}$	$+125^{\circ}\text{C}$
1					6	4	6	6	10lo	20lo
1,5 ~ 68	-10	+10	+12	10	6	10	10			
100 ~ 680				12	8	12	12			
680 ~ 1500				14	10	14	14			

LOW ESR CHIP Tantalum Capacitor Alternate to KEMET Serie 520

Part No.: **I17042**

DRW:	Jason	CHKD	Wilson	MATL:	Wilson	TOLERANCE	Mason	DATE	20.05.2010	Customer:
APPD:	Schumi			FINISH	Jamy		Sheet No.	1 from 5		

EDCON-COMPONENTS



Moist

Test conditions:

Relative Humidity:	90 to 95% without load
Ambient Temperature:	.+ 40°C
Duration:	500 hours
Post rest requirement at 20°C	
Leakage current:	≤ Initial specified value.
Capacitance change:	+/- 10% of initial measured value
tan	≤ Initial specified value.

Shell Life

Test conditions		Post test requirements at +20°C
Duration:	2000 hours	Same limits for Endurance.
Ambient temperature:	. +125°C	
Applied Voltage:	(none)	

Solder Heat Resistance

The Capacitor shall withstand dipping into solder bath for 5 +/-1 seconds at 260 +/-5°C

Endurance

Test conditions

Conditions Item	Derating	Rating
Duration	2000 hours	2000 hours
Ambient temperature	. +125°C	. +85°C
Applied Voltage	Derating working voltage	Rated working voltage
Source impedance	1Ω/V	1Ω/V

Derating Voltage +125°C for 10~50V working

Rated Voltage	4,0	6,3	10,0	16,0	20,0	25,0	35,0	50,0
Voltage Derating	2,5	4,0	6,3	10,0	13,0	16,0	23,0	33,0
Surge Voltage +85°C	5,0	8,0	13,0	20,0	26,0	32,0	46,0	65,0
Surge Voltage +0°C	3,4	5,0	9,0	12,0	16,0	20,0	26,0	38,0

Post test requirements 5.0 at +20°C

Leakage Current	≤ 125% of initial specified value
Capacitance Change	.+/- 10% of initial measured value.
tan	≤ initial specified value

**LOW ESR CHIP Tantalum
Capacitor Alternate to KEMET
Serie 520**

Part No.: **I17042**

DRW:	Jason	CHKD	Wilson	MATL:	Wilson	TOLERANCE	Mason	DATE	20.05.2010	Customer:
APPD:	Schumi			FINISH	Jamy		Sheet No.	2 from 5		

EDCON-COMPONENTS



Packing Specification

Dimensions of the carrier tape and standards parts quantity per reel



Case Size	A +/- 0,1	B +/- 0,1	C +/- 0,1	D +/- 0,1	E +/- 0,1	F +/- 0,1	G +/- 0,1	H +/- 0,1	J +/- 0,1	K max.	t	Quantity
S	1,6	2,4	8	3,5	1,75	4	2	4	1,5	2,5	0,2	2000
A	1,9	3,5	8	3,5	1,75	4	2	4	1,5	2,5	0,2	2000
B	3,1	3,8	8	3,5	1,75	4	2	4	1,5	2,5	0,2	2000
C	3,6	6,4	12	5,5	1,75	8	2	4	1,5	3	0,3	500
D	4,7	7,7	12	5,5	1,75	8	2	4	1,5	3,4	0,3	500
E	4,6	7,6	12	5,5	1,75	8	2	4	1,5	4,6	0,3	400
V	6,4	7,4	12	5,5	1,75	8	2	4	1,5	3,8	0,3	400

Tape width	8	12
A	Ø 180	←
B	Ø 60	←
C +/-0.2	Ø 13	←
D +/-0.2	Ø 21	←
E +/-0.5	2,0	←
W +/-0.3	9,0	13,0
t +/-0.4	1,3	←
R +/-0.4	10,5	←

Reel Dimensions Unit (mm)

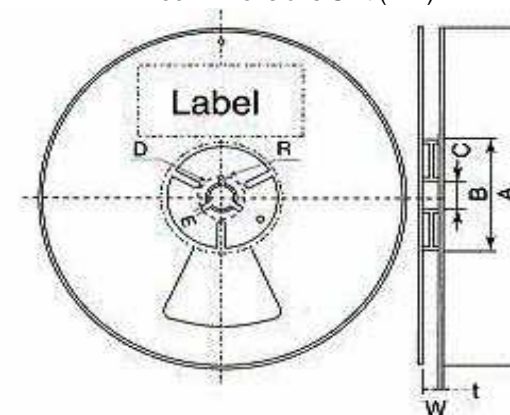

Tape Leader and Tailer



LOW ESR CHIP Tantalum Capacitor Alternate to KEMET Serie 520

Part No.: **I17042**

DRW:	Jason	CHKD	Wilson	MATL:	Wilson	TOLERANCE	Mason	DATE	20.05.2010	Customer:
APPD:	Schumi			FINISH	Jamy		Sheet No.	3 from 5		

EDCON-COMPONENTS



Ordering Informations

Serie	Voltage	Tol.	Range Cod.	Case Code	ESR	ROHS	Package			
I17042	160	K	336	C	0150	R	TR			

160= 16 Volt	K= Tol. 10%	336= 33µF	C= Size Code	0150= 150 Milliohms	R= ROHS Conform	TR= Tape / Reel
	M= Tol. 20%				N= NON ROHS Conform	

LOW ESR CHIP Tantalum Capacitor Alternate to KEMET Serie 520

Part No.: **I17042**

DRW:	Jason	CHKD	Wilson	MATL:	Wilson	TOLERANCE	Mason	DATE	20.05.2010
APPD:	Schumi			FINISH	Jamy		Sheet No.		4 from 5

Customer:



Soldering Profile Curve

Classification Reflow Profile (JEDEC J-STD-020C)



**LOW ESR CHIP Tantalum
Capacitor Alternate to KEMET
Serie 520**

Part No.: **I17042**

DRW:	Jason	CHKD	Wilson	MATL:	Wilson	TOLERANCE	Mason	DATE	20.05.2010	Customer:
APPD:	Schumi			FINISH	Jamy		Sheet No.	5 from 5		