

# EDCON-COMPONENTS



## Specifications

Polymer Tantalum Solid Electrolytic Capacitors Chip Type

Operating temperature Range  $-55^{\circ}\text{C} \sim +125^{\circ}\text{C}$  ( $85^{\circ}\text{C}$  with rated voltage derating).

Capacitance tolerance:  $\pm 20\%$ .

DC leakage, dissipation factor and ESR at  $25^{\circ}\text{C}$ .

Taping and reeling per EIA481-1 Specification.

General purpose surface mount type.

Compact size & wide CV range.

High Solderability & stabler characteristics for soldering.

Compatible with all popular automatic pick and place equipment.

## Technical Drawing

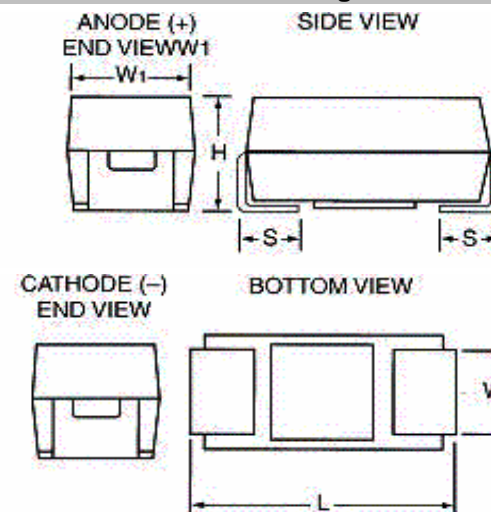

Technical	Performance Characteristics
Operating Temperature Range:	$-55^{\circ}\text{C} \sim +125^{\circ}\text{C}$
Rated Working Voltage:	4 to 10VDC
Nominal Capacitance Range:	0,1 to 1500 $\mu\text{F}$
Capacitance Tolerance:	$\pm 20\%$ / $\pm 10\%$ (120Hz $\pm 20^{\circ}\text{C}$ )
Leakage Current:	Not more than 0,01CV ( $\mu\text{A}$ ) or 0,5 $\mu\text{A}$ whichever is greater

## Dimensions

Case Size	L= $\pm 0,2$	W1= $\pm 7-0,2$	H= $\pm 0,2$	S= $\pm 0,2$	W2= $\pm 0,2$
A	3,2	1,6	1,6	0,8	1,2
B	3,5	2,8	1,9	0,8	2,2
C	6,0	3,2	2,5	1,3	2,2
D	7,3	4,3	2,8	1,3	2,4

Characteristics at High and Low Temperature	capacitance ( $\mu\text{F}$ )	Capacitance Change (%)			DF Max. (%)				DCL Max. ( $\mu\text{F}$ )	
		$-55^{\circ}\text{C}$	$+85^{\circ}\text{C}$	$+125^{\circ}\text{C}$	$-55^{\circ}\text{C}$	$+20^{\circ}\text{C}$	$+55^{\circ}\text{C}$	$+125^{\circ}\text{C}$	$+85^{\circ}\text{C}$	$+125^{\circ}\text{C}$
1	1,5 ~ 68 100 ~ 680 680 ~ 1500	-10	+10	+12	6	4	6	6	10lo	20lo
10					6	10	10			
12					8	12	12			
14					10	14	14			

**Polymer CHIP Tantalum Capacitor 10V**

Part No.: **I17010**

DRW:	Jason	CHKD	Wilson	MATL:	Wilson	TOLERANCE	Mason	DATE	20.05.2010	Customer:
APPD:	Schumi			FINISH	Jamy		Sheet No.	1 from 5		

[www.edcon-components.com](http://www.edcon-components.com)

email: [info@edcon-components.com](mailto:info@edcon-components.com)

# EDCON-COMPONENTS



## Moisture Resistance

Test conditions:

Relative Humidity:	90 to 95% without load
Ambient Temperature:	.+ 40°C
Duration:	500 hours
Post rest requirement at 20°C	
Leakage current:	≤ Initial specified value.
Capacitance change:	+/- 10% of initial measured value
tan	≤ Initial specified value.

## Shell Life

Test conditions		Post test requirements at +20°C
Duration:	2000 hours	Same limits for Endurance.
Ambient temperature:	. +125°C	
Applied Voltage:	(none)	

## Solder Heat Resistance

The Capacitor shall withstand dipping into solder bath for 5 +/-1 seconds at 260 +/-5°C

## Endurance

Test conditions

Conditions Item	Derating	Rating
Duration	2000 hours	2000 hours
Ambient temperature	. +125°C	. +85°C
Applied Voltage	Derating working voltage	Rated working voltage
Source impedance	1Ω/V	1Ω/V

Derating Voltage +125°C for 10~50V working

Rated Voltage	4,0	6,3	10,0	16,0	20,0	25,0	35,0	50,0
Voltage Derating	2,5	4,0	6,3	10,0	13,0	16,0	23,0	33,0
Surge Voltage +85°C	5,0	8,0	13,0	20,0	26,0	32,0	46,0	65,0
Surge Voltage +0°C	3,4	5,0	9,0	12,0	16,0	20,0	26,0	38,0

Post test requirements 5.0 at +20°C

Leakage Current	≤ 125% of initial specified value
Capacitance Change	.+/- 10% of initial measured value.
tan	≤ initial specified value

**Polymer CHIP Tantalum Capacitor 10V**

Part No.: **I17010**

DRW:	Jason	CHKD	Wilson	MATL:	Wilson	TOLERANCE	Mason	DATE	20.05.2010	Customer:
APPD:	Schumi			FINISH	Jamy		Sheet No.	2 from 5		

[www.edcon-components.com](http://www.edcon-components.com)

email: [info@edcon-components.com](mailto:info@edcon-components.com)

# EDCON-COMPONENTS



## Packing Specification

Dimensions of the carrier tape and standards parts quantity per reel



Case Size	A +/- 0,1	B +/- 0,1	C +/- 0,1	D +/- 0,1	E +/- 0,1	F +/- 0,1	G +/- 0,1	H +/- 0,1	J +/- 0,1	K max.	t	Quantity
A	1,9	3,5	8	3,5	1,75	4	2	4	1,5	2,5	0,2	2000
B	3,1	3,8	8	3,5	1,75	4	2	4	1,5	2,5	0,2	2000
C	3,6	6,4	12	5,5	1,75	8	2	4	1,5	3	0,3	500
D	4,7	7,7	12	5,5	1,75	8	2	4	1,5	3,4	0,3	500

Tape width	8	12
A	Ø 180	←
B	Ø 60	←
C +/-0.2	Ø 13	←
D +/-0.2	Ø 21	←
E +/-0.5	2,0	←
W +/-0.3	9,0	13,0
t +/-0.4	1,3	←
R +/-0.4	10,5	←

Reel Dimensions Unit (mm)

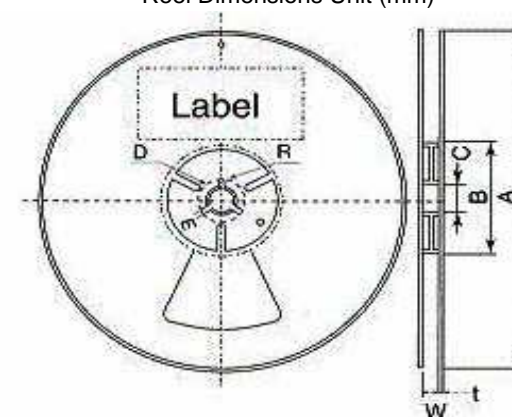

Tape Leader and Tailer



**Polymer CHIP Tantalum Capacitor 10V**

Part No.: **I17010**

DRW:	Jason	CHKD	Wilson	MATL:	Wilson	TOLERANCE	Mason	DATE	20.05.2010	Customer:
APPD:	Schumi			FINISH	Jamy		Sheet No.	3 from 5		

# EDCON-COMPONENTS



Capacitance	DCL (µA) max.	DF % max.	ESR max. (mΩ) @ 100 KHz
220µF	220µA	10%	25mΩ

## Ordering Informations

Serie	Voltage	Tol.	Range Cod.	Case Code	ESR	ROHS	Package			
<b>I17010</b>	<b>100</b>	<b>K</b>	<b>227</b>	<b>D</b>	<b>0025</b>	<b>R</b>	<b>TR</b>			

<b>100=</b> 10 Volt	<b>K=</b> Tol. 10%	<b>227=</b> 220µF	<b>D=</b> Size Code	<b>0025=</b> 25 Milliohms	<b>R=</b> ROHS Conform	<b>TR=</b> Tape / Reel
	<b>M=</b> Tol. 20%				<b>N=</b> NON ROHS Conform	

**Polymer CHIP Tantalum Capacitor 10V**

Part No.: **I17010**

DRW:	Jason	CHKD	Wilson	MATL:	Wilson	TOLERANCE	Mason	DATE	20.05.2010
APPD:	Schumi			FINISH	Jamy		Sheet No.		4 from 5

Customer:



Soldering Profile Curve

Classification Reflow Profile (JEDEC J-STD-020C)



**Polymer CHIP Tantalum Capacitor 10V**

Part No.: **I17010**

DRW:	Jason	CHKD	Wilson	MATL:	Wilson	TOLERANCE	Mason	DATE	20.05.2010	Customer:
APPD:	Schumi			FINISH	Jamy		Sheet No.	5 from 5		