

EDCON-COMPONENTS



Specifications

Standard Tantalum Solid Electrolytic Capacitors Chip Type

Operating temperature Range $-55^{\circ}\text{C} \sim +125^{\circ}\text{C}$ (85°C with rated voltage derating).

Capacitance tolerance: $\pm 20\%$.

DC leakage, dissipation factor and ESR at 25°C .

Taping and reeling per EIA481-1 Specification.

General purpose surface mount type.

Compact size & wide CV range.

High Solderability & stabler characteristics for soldering.

Compatible with all popular automatic pick and place equipment.

Technical Drawing



Technical	Performance Characteristics
Operating Temperature Range:	$-55^{\circ}\text{C} \sim +125^{\circ}\text{C}$
Rated Working Voltage:	4 to 50VDC
Nominal Capacitance Range:	0,1 to 1500 μF
Capacitance Tolerance:	$\pm 20\%$ / $\pm 10\%$ (120Hz $\pm 20^{\circ}\text{C}$)
Leakage Current:	Not more than 0,01CV (μA) or 0,5 μA whichever is greater

Dimensions

Case Size	L= $\pm 0,2$	W1= $\pm 7-0,2$	H= $\pm 0,2$	S= $\pm 0,2$	W2= $\pm 0,2$
S	2,0	1,2	1,2	0,5	1,2
A	3,2	1,6	1,6	0,8	1,2
B	3,5	2,8	1,9	0,8	2,2
C	6,0	3,2	2,5	1,3	2,2
D	7,3	4,3	2,8	1,3	2,4
E	7,3	4,3	4,0	1,3	2,4
V	7,3	6,1	3,5	1,4	3,1

Characteristics at High and Low Temperature	capacitance (μF)	Capacitance Change (%)			DF Max. (%)				DCL Max. (μF)	
		-55°C	$+85^{\circ}\text{C}$	$+125^{\circ}\text{C}$	-55°C	$+20^{\circ}\text{C}$	$+55^{\circ}\text{C}$	$+125^{\circ}\text{C}$	$+85^{\circ}\text{C}$	$+125^{\circ}\text{C}$
1	1,5 ~ 68 100 ~ 680 680 ~ 1500	-10	+10	+12	6	4	6	6	10lo	20lo
10					6	10	10			
12					8	12	12			
14					10	14	14			

**Standard Tantalum Capacitor
Alternate to KEMET**

Part No.: **I17001**

DRW:	Jason	CHKD	Wilson	MATL:	Wilson	TOLERANCE	Mason	DATE	20.05.2010	Customer:
APPD:	Schumi			FINISH	Jamy		Sheet No.	1 from 5		

www.edcon-components.com

email: info@edcon-components.com

EDCON-COMPONENTS



Moisture Resistance

Test conditions:

Relative Humidity:	90 to 95% without load
Ambient Temperature:	.+ 40°C
Duration:	500 hours
Post rest requirement at 20°C	
Leakage current:	≤ Initial specified value.
Capacitance change:	+/- 10% of initial measured value
tan	≤ Initial specified value.

Shell Life

Test conditions		Post test requirements at +20°C
Duration:	2000 hours	Same limits for Endurance.
Ambient temperature:	. +125°C	
Applied Voltage:	(none)	

Solder Heat Resistance

The Capacitor shall withstand dipping into solder bath for 5 +/-1 seconds at 260 +/-5°C

Endurance

Test conditions

Conditions Item	Derating	Rating
Duration	2000 hours	2000 hours
Ambient temperature	. +125°C	. +85°C
Applied Voltage	Derating working voltage	Rated working voltage
Source impedance	1Ω/V	1Ω/V

Derating Voltage +125°C for 10~50V working

Rated Voltage	4,0	6,3	10,0	16,0	20,0	25,0	35,0	50,0
Voltage Derating	2,5	4,0	6,3	10,0	13,0	16,0	23,0	33,0
Surge Voltage +85°C	5,0	8,0	13,0	20,0	26,0	32,0	46,0	65,0
Surge Voltage +0°C	3,4	5,0	9,0	12,0	16,0	20,0	26,0	38,0

Post test requirements 5.0 at +20°C

Leakage Current	≤ 125% of initial specified value
Capacitance Change	.+/- 10% of initial measured value.
tan	≤ initial specified value

**Standard Tantalum Capacitor
Alternate to KEMET**

Part No.: **I17001**

DRW:	Jason	CHKD	Wilson	MATL:	Wilson	TOLERANCE	Mason	DATE	20.05.2010	Customer:
APPD:	Schumi			FINISH	Jamy		Sheet No.	2 from 5		

EDCON-COMPONENTS



Packing Specification

Dimensions of the carrier tape and standards parts quantity per reel



Case Size	A +/- 0,1	B +/- 0,1	C +/- 0,1	D +/- 0,1	E +/- 0,1	F +/- 0,1	G +/- 0,1	H +/- 0,1	J +/- 0,1	K max.	t	Quantity
S	1,6	2,4	8	3,5	1,75	4	2	4	1,5	2,5	0,2	2000
A	1,9	3,5	8	3,5	1,75	4	2	4	1,5	2,5	0,2	2000
B	3,1	3,8	8	3,5	1,75	4	2	4	1,5	2,5	0,2	2000
C	3,6	6,4	12	5,5	1,75	8	2	4	1,5	3	0,3	500
D	4,7	7,7	12	5,5	1,75	8	2	4	1,5	3,4	0,3	500
E	4,6	7,6	12	5,5	1,75	8	2	4	1,5	4,6	0,3	400
V	6,4	7,4	12	5,5	1,75	8	2	4	1,5	3,8	0,3	400

Tape width	8	12
A	∅ 180	←
B	∅ 60	←
C +/-0.2	∅ 13	←
D +/-0.2	∅ 21	←
E +/-0.5	2,0	←
W +/-0.3	9,0	13,0
t +/-0.4	1,3	←
R +/-0.4	10,5	←

Reel Dimensions Unit (mm)

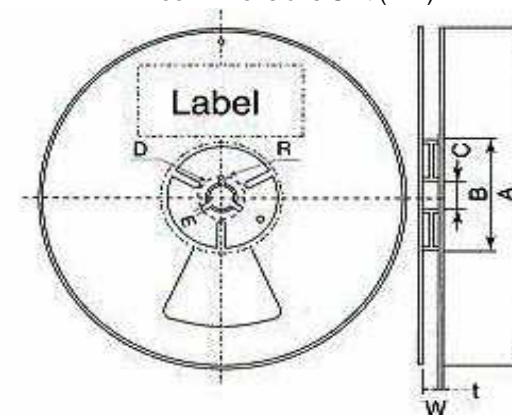

Tape Leader and Tailer



**Standard Tantalum Capacitor
Alternate to KEMET**

Part No.: **I17001**

DRW:	Jason	CHKD	Wilson	MATL:	Wilson	TOLERANCE	Mason	DATE	20.05.2010	Customer:
APPD:	Schumi			FINISH	Jamy		Sheet No.	3 from 5		

EDCON-COMPONENTS



Ordering Informations

Serie	Voltage	Tol.	Range Cod.	Case Code	ROHS	Package				
I17001	250	M	226	D	R	TR				

250= 25Volt	M= Tol. 20%	226= 22µF	D= Size Code	R= ROHS Conform	TR= Tape / Reel
	K= Tol. 10%			N= NON ROHS Conform	

**Standard Tantalum Capacitor
Alternate to KEMET**

Part No.: **I17001**

DRW:	Jason	CHKD	Wilson	MATL:	Wilson	TOLERANCE	Mason	DATE	20.05.2010
APPD:	Schumi			FINISH	Jamy		Sheet No.	4 from 5	Customer:



Soldering Profile Curve

Classification Reflow Profile (JEDEC J-STD-020C)



Standard Tantalum Capacitor Alternate to KEMET	
Part No.:	I17001
Customer:	

DRW:	Jason	CHKD	Wilson	MATL:	Wilson	TOLERANCE	Mason	DATE	20.05.2010
APPD:	Schumi			FINISH	Jamy		Sheet No.	5 from 5	