



Technical Informations

FEATURES

Magnetic Shielded surface mount inductor with high current rating.
Low resistance to keep power loss minimum.

OPTIONS

Tape & Reel (Standard)
Tolerance: M=20% (Standard,)
Tighter Tolerances Available

APPLICATIONS

Excellent for power line DC-DC conversions used in hard disk, notebook computer and other electronic equipment.

PHYSICAL CHARACTERISTICS

- Inductance is measured by LCR-meter 4284A / 4286A (HP) or equivalent.
 - DC Resistance is measured by HP4338B Milliohms Meter or equivalent.
 - Rated current is measured by LCR-meter 3260B (WK) & DC Bias 3265B(WK).
 - Maximum allowable DC current is that which causes a 25% inductance reduction from the initial value, or coil temperature to rise by 40°C, whichever is smaller.
- Ambient Temperature . -40°C to + 85°C
- Operating Temperature . -40°C to + 125°C
 - Storage Temperature . -20°C to + 60°C 75%RH max

ELECTRICAL SPECIFICATIONS

Inductance	Test-Freq.	DCR (Ω)		Saturation Current (A)			Temperature		
		at 20°C		at 25°C		at 125°C	Rise Current (A)		
(μH)	KHz	Max	Typ.	Typ.	Max	Typ.	Max	Typ.	Max
1200	1	1,33	1,11	0,64	0,81	0,52	0,65	0,79	0,90

1. Saturation current: The DC current at which the inductance decreased to 90% of its initial value.
2. Temperature rise current: The DC current at which the temperature rise $\Delta T=40^{\circ}\text{C}$. ($T_a=20^{\circ}\text{C}$)

1. This electronic component is meant to be used in general electronic equipment. Before the incorporation of this component into any equipment with higher and more reliable requirements such as aviation, aerospace, submarine, nuclear control, transportation, transportation signal, disaster prevention, medical, public information network, etc. or if there is a possibility of injuries or damages to the human body, Edcon -Components must be informed before the stage of design-in. Evaluation checks for safety have to be performed on each electronic components used in electrical circuits that require high safety and reliability functions.

**SMT SHIELDED
POWER INDUCTOR High
Current**

Part No.: **S47007-122**

Customer:

DRW:	Chang	CHKD	Young	MATL:	Chu Chi	DATE	31.05.2018
APPD:	Pong			FINISH	Vienna	Sheet	1 from 3

Copyright by S.Tiede

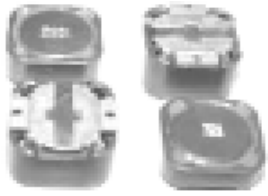

TECHNICAL Dimensions (mm)

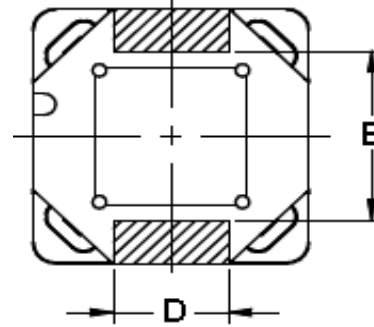
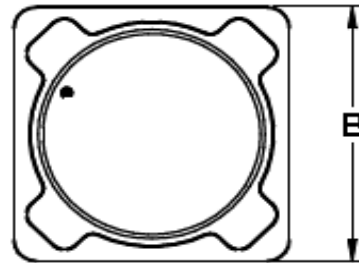
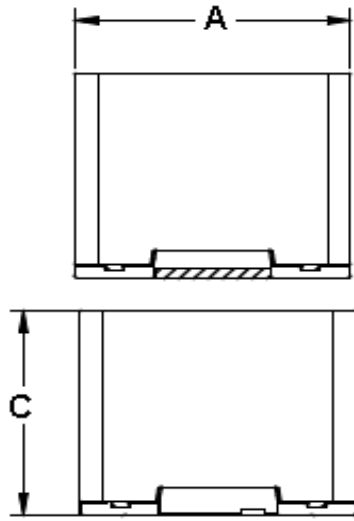

A=	12,0 ± 0,3
B=	12,0 ± 0,3
C=	10,0 max
D=	5,4 ± 0,2
E=	6,8 ± 0,2

Ordering Information

Serie and Range	Tolerance	ROHS	Packing
S47007-122	M	R	TR

K = 10%	R = ROHS	BU = Bulk Ware
M = 20%	N = non ROHS	TR = Tape Reel

Soldering Profile for Lead Free Soldering 235-240°C

Classification Reflow Profile (JEDEC J-STD-020C)

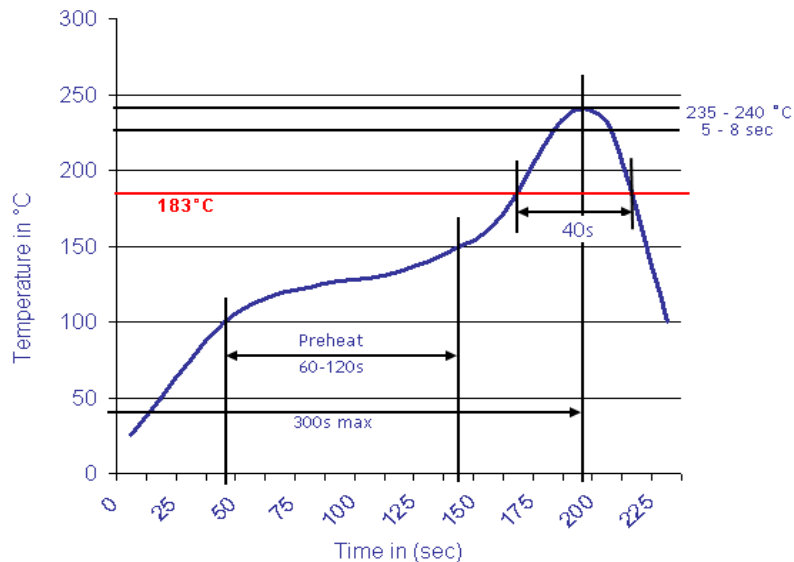

1. This electronic component is meant to be used in general electronic equipment. Before the incorporation of this component into any equipment with higher and more reliable requirements such as aviation, aerospace, submarine, nuclear control, transportation, transportation signal, disaster prevention, medical, public information network, etc. or if there is a possibility of injuries or damages to the human body, Edcon -Components must be informed before the stage of design-in. Evaluation checks for safety have to be performed on each electronic components used in electrical circuits that require high safety and reliability functions.

**SMT SHIELDED
POWER INDUCTOR High
Current**

Part No.: **S47007-122**

Customer:

DRW:	Chang	CHKD	Young	MATL:	Chu Chi	DATE	31.05.2018
APPD:	Pong			FINISH	Vienna	Sheet	2 from 3

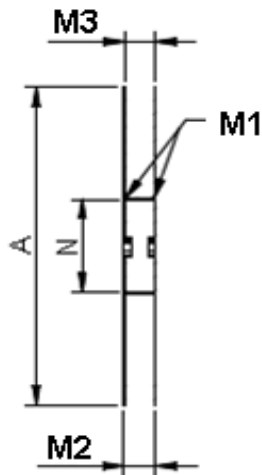
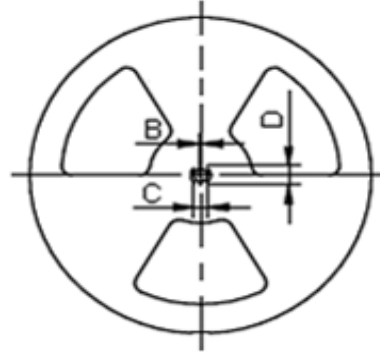
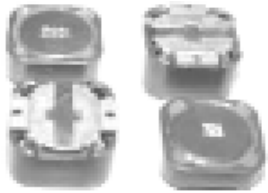

	Dimension (mm)									
	A	B	C	D	N	M1	M2	M3	M3	
Tolerance	± 2.0	min.	min.	min.	± 2.0	± 2.0	max.	min.	max.	
Tape width 24mm	330	1,5	12,8	20,2	60,0	24,4	30,4	23,9	27,4	

1. This electronic component is meant to be used in general electronic equipment. Before the incorporation of this component into any equipment with higher and more reliable requirements such as aviation, aerospace, submarine, nuclear control, transportation, transportation signal, disaster prevention, medical, public information network, etc. or if there is a possibility of injuries or damages to the human body, Edcon –Components must be informed before the stage of design-in. Evaluation checks for safety have to be performed on each electronic components used in electrical circuits that require high safety and reliability functions.

**SMT SHIELDED
POWER INDUCTOR High
Current**

Part No.: **S47007-122**

Customer:

DRW:	Chang	CHKD	Young	MATL:	Chu Chi	DATE	31.05.2018
APPD:	Pong			FINISH	Vienna	Sheet	3 from 3

Copyright by S.Tiede