

EDCON-COMPONENTS



SPECIFICATIONS : Slide switches are known for providing selection of two or more switch positions for engagement of respective switch contacts. Electrical slide switches have long been used to control the operation of many devices, including volume and other controls for audio & video equipment, dimmer controls for lights among a multitude of other daily electrical products. Such slide switches have also been used for controlling the operating speed of many kinds of variable speed hand tools. In electrical slide switches a slide member is slidably repositionable to affect a switching action.

Contact Material Silver plated Code 1

Fixed Terminal: Silver plated over copper alloy
 Moving Contact: Silver plated over copper alloy
 Contact Rating: 6A with resistive load 120VAX or 28VDC
 3A with resistive load 250VAC

Contact Material Gold plated Code 2

Fixed Terminal: Copper Alloy with gold plated over nickel plated
 Moving Contact: Copper Alloy with gold plated over nickel plated
 Contact Rating: 0,4 Volt-Amps (VA max. @ 20V max.AC or DC)

Electrical Specifications and Material

Electrical Life: 60.000 make and break cycles at full load
 Contact Resistance: 10mΩ max. initial @2-4VDC. 100mA for both silver and gold plated contacts.
 Insulation Resistance: 1000M Ω min.
 Dielectric Strength: 1000V RMS min. @ sea level
 Operating Temperature: -30°C to +130°C
 Case: Diallyl phthalate (DAP) (UL94V-0)
 Actuator: Nylon, Black Standard
 Housing: Stainless steel
 Switch Support: Brann,tin plated
 Terminal/Contact: Silver or gold plated
 Terminal Seal: Epoxy

Technical Drawing

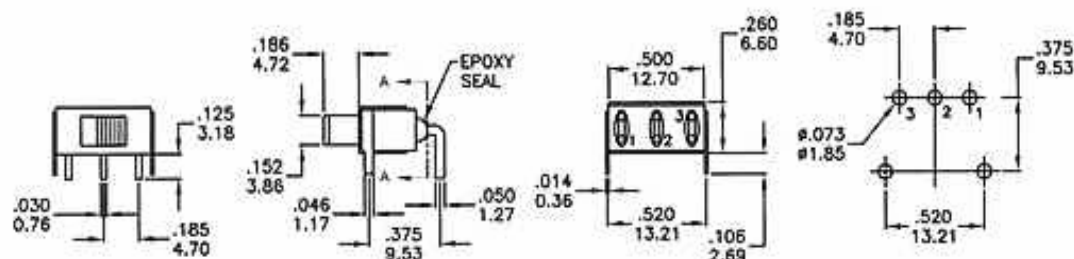

SLIDE-SWITCH

Part No.: **Q52A1003**

DRW:	Jason	CHKD	Wilson	MATL:	Wilson	TOLERANCE	Mason	DATE	10.04.2009	Customer:
APPD:	Schumi			FINISH	Jamy		Sheet No.	1 from 4		

EDCON-COMPONENTS



Actuator Type 1

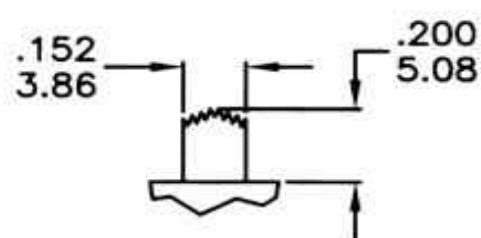

Terminations Type A

Actuator Type 2

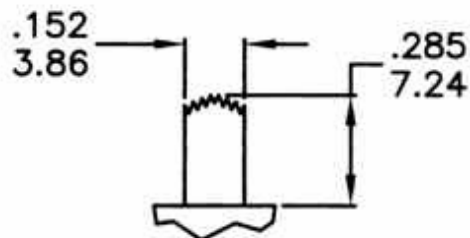

Terminations Type B

Actuator Type 3

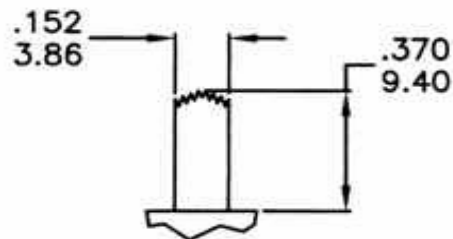

Terminations Type C

Actuator Type 4

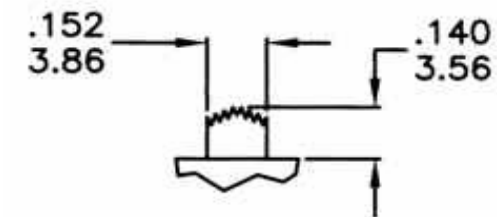

Terminations Type D

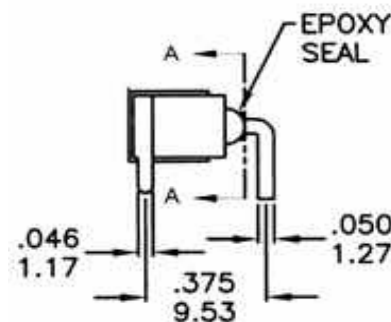

SLIDE-SWITCH

Part No.: **Q52A1003**

DRW:	Jason	CHKD	Wilson	MATL:	Wilson	TOLERANCE	Mason	DATE	10.04.2009
APPD:	Schumi			FINISH	Jamy		Sheet No.	2 from 4	Customer:

www.edcon-components.com

email: info@edcon-components.com

EDCON-COMPONENTS



Connected Terminals Cematic						
Switch function	Pos.1	Pos2	Pos3	Pos 1	Pos 2	Pos 3
A1	ON	NONE	OFF			
A2	ON	NONE	ON	.2-1	OPEN	.2-3
A3	ON	OFF	ON			

Ordering Informations

Serie	Switch function	ACTUATOR	TERMINATIONS	CONTACT MATERIAL	SEAL	ROHS	Packing			
Q52A1003	A	1	C	1	A	R	BU1			

A= A1	1= C1	C= A3	1= Silver	A= Epoxy	R= Rohs conform	BU1= 100PCS per Bag
B= A2	2= C2		2= Gold plated	B= No Epoxy		
C= A3	3= C3					
	4= C4					

SLIDE-SWITCH

Part No.: **Q52A1003**

DRW:	Jason	CHKD	Wilson	MATL:	Wilson	TOLERANCE	Mason	DATE	10.04.2009
APPD:	Schumi			FINISH	Jamy			Sheet No.	3 from 4

Customer:



Lead Free Soldering curve

Classification Reflow Profile (JEDEC J-STD-020C)

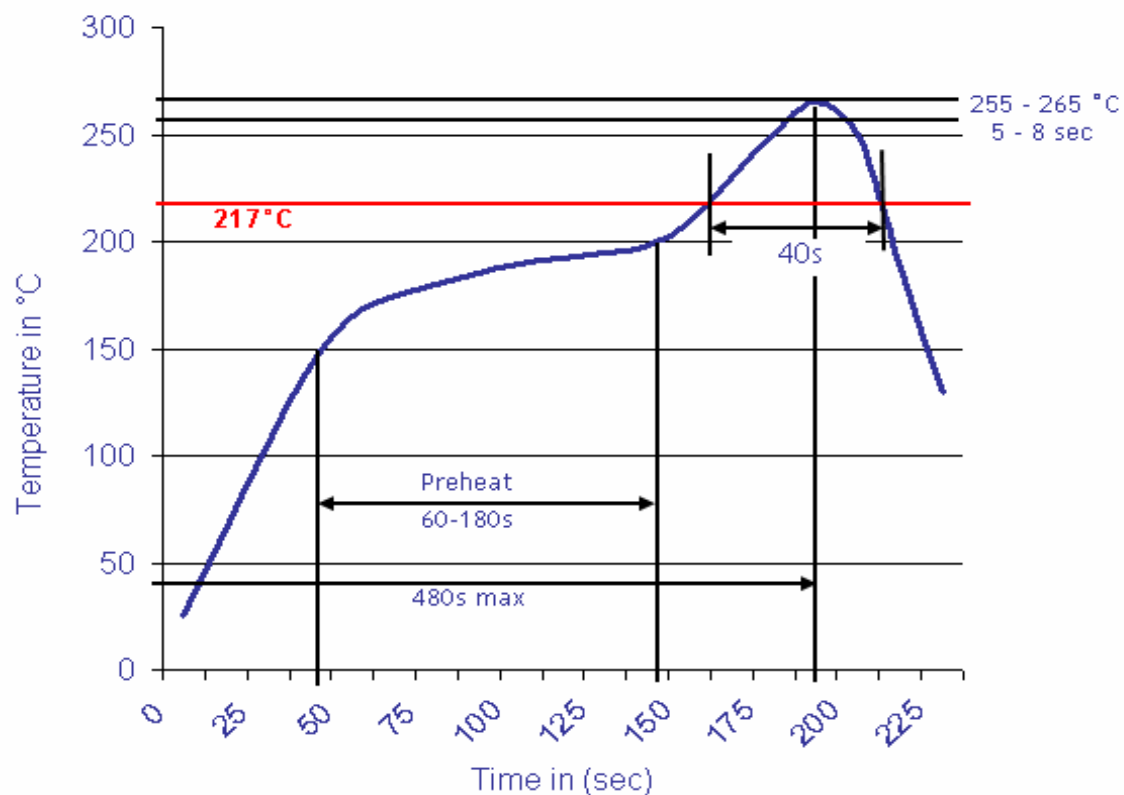

SLIDE-SWITCH	
Part No.:	Q52A1003
Customer:	

DRW:	Jason	CHKD	Wilson	MATL:	Wilson	TOLERANCE	Mason	DATE	10.04.2009
APPD:	Schumi			FINISH	Jamy		Sheet No.	4 from 4	