



Technical Specification

Features

Wire Wound Construction
High Saturation Material
Polyolefin Shrink Tubing
Low DC Resistance
High Reliability

Applications

Switching Regulators
RFI Suppression Filters
SCR and TRIAC Controls Systems
Automotive Systems
Filters

Electrical Schematic



Dimensions

A (mm)	B (mm)	P (mm)	E (mm)
60,96	38,10	12,70	2,54
F (mm)	C (mm)	D (mm)	
6,35	45,72	3,05	

Dimensions

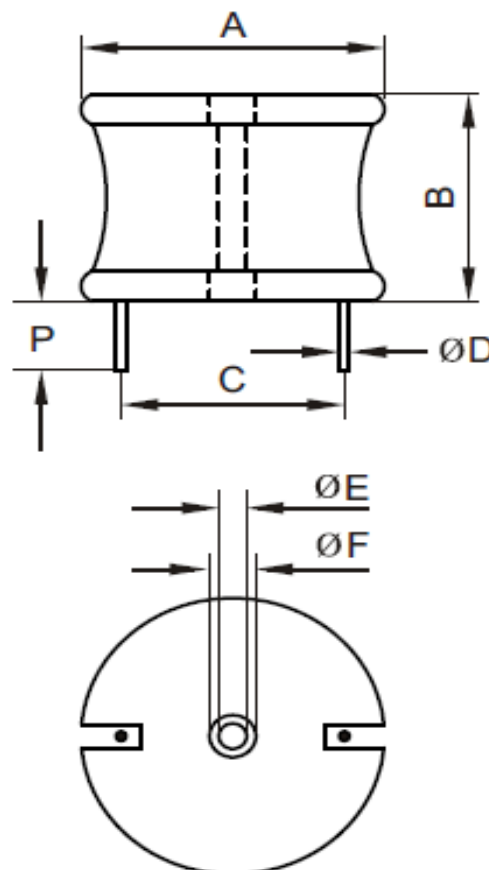

Electrical Characteristics

Technical Information

Testing LCR Bridge, measured @ 1KHz 0,1V HP4284A
Equivalent acceptable
RDC. QuadTech 1880 Milliohm meter
IDC: Max. Lowers inductance by 10%
Operating Temperature: -40°C ~ +85°C
Storage Temperature: -40°C ~ +125°C
Solder Methods: Vapor Phase, Infrared Reflow
Marking: Inductance and tolerance
Note: All specifications subject to change without notice.
Moisture Resistance: L/L 10%

Inductance	Inductance Code	IDC	DCR max.
68μH	680	35,0A	0,0078Ω

THT Radial Extremely High Current

Part No.: **S10R48**

Customer:

DRW:	Jason	CHKD	Jules	MATL:	Wu	DATE	18.05.2009
APPD:	Join			FINISH	Shieh	Sheet	1 from 2



Soldering Profile

Classification Reflow Profile (JEDEC J-STD-020C)

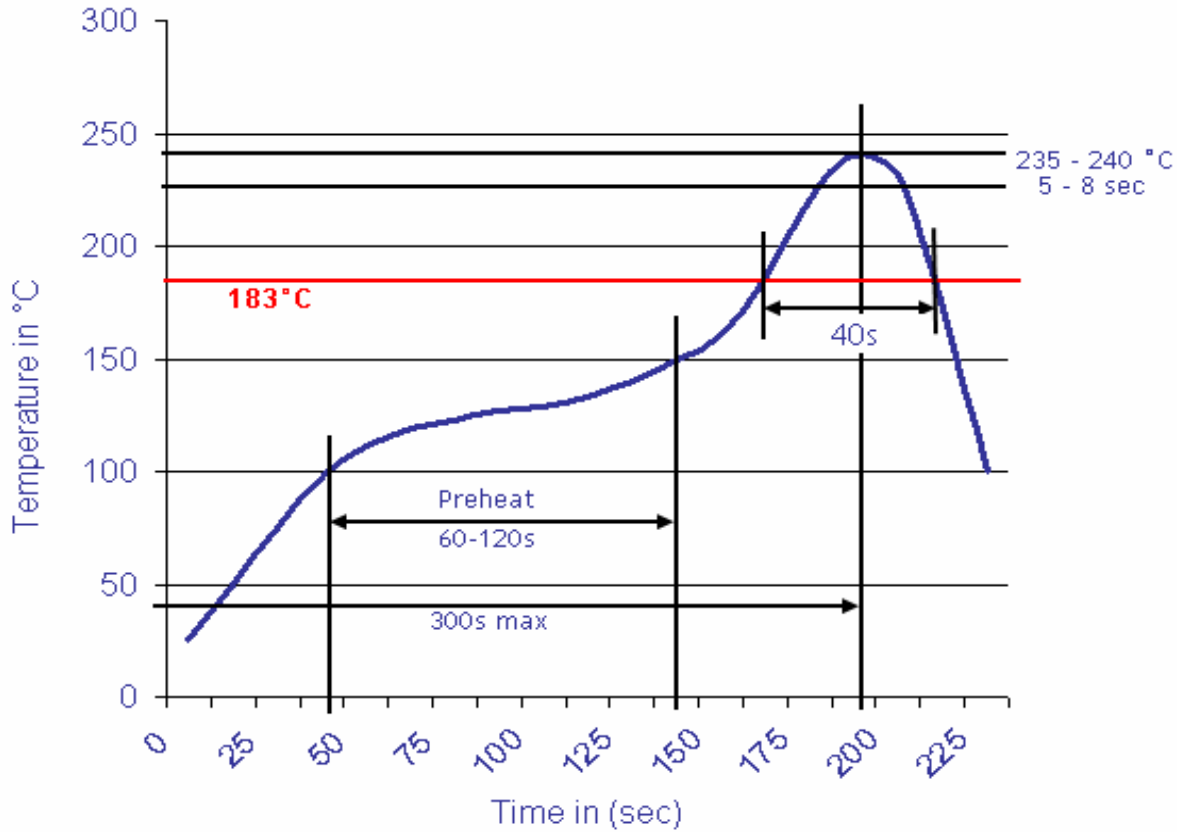

Ordering Information

Serie	Inductance	Tolerance	No Function	ROHS	Packing
-------	------------	-----------	-------------	------	---------

S10R48	680	K	0	R	BU10
---------------	------------	----------	----------	----------	-------------

680 = 68µH	K = Tol. 10%	0 = No function	R = ROHS conform	BU = Bulk Ware
	J = Tol. 5%		N =NON ROHS conform	TY = Tray Package

THT Radial Extremely High Current	
Part No.:	S10R48
Customer:	

DRW:	Jason	CHKD	Jules	MATL:	Wu	DATE	18.05.2009
APPD:	Join			FINISH	Shieh	Sheet	2 from 2

