



Technical Specification

Features

Wire Wound Construction
 High Saturation Material
 Polyolefin Shrink Tubing
 Low DC Resistance
 High Reliability

Applications

Switching Regulators
 RFI Suppression Filters
 SCR and TRIAC Controls Systems
 Automotive Systems
 Filters

Electrical Schematic



Dimensions

A (mm)	B (mm)	P (mm)	E (mm)
50,80	38,10	12,70	2,54
F (mm)	C (mm)	D (mm)	
6,35	37,60	2,67	

Dimensions

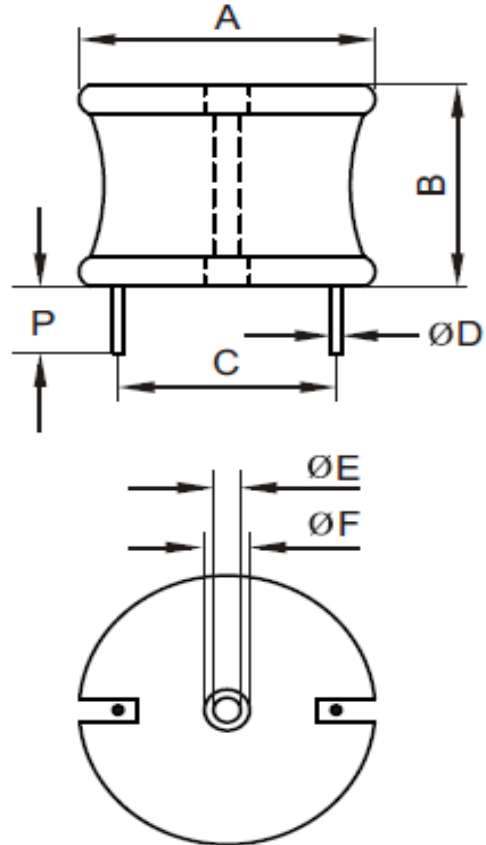

Electrical Characteristics

Technical Information

Testing LCR Bridge, measured @ 1KHz 0,1V HP4284A
 Equivalent acceptable
 RDC. QuadTech 1880 Milliohm meter
 IDC: Max. Lowers inductance by 10%
 Operating Temperature: -40°C ~ +85°C
 Storage Temperature: -40°C ~ +125°C
 Solder Methods: Vapor Phase, Infrared Reflow
 Marking: Inductance and tolerance
 Note: All specifications subject to change without notice.
 Moisture Resistance: L/L 10%

Inductance	Inductance Code	IDC	DCR max.
15μH	150	35,00A	0,0040Ω

THT Radial Extremely High Current

Part No.: **S10R46**

Customer:

DRW:	Jason	CHKD	Jules	MATL:	Wu	DATE	18.05.2009
APPD:	Join			FINISH	Shieh	Sheet	1 from 2

Copyright by EDCON-COMPONENTS H.Schmitt 20.6.2008



Soldering Profile

Classification Reflow Profile (JEDEC J-STD-020C)



Ordering Information

Serie	Inductance	Tolerance	No Function	ROHS	Packing
S10R46	150	K	0	R	BU10

150= 15µH	K= Tol. 10%	0= No function	R= ROHS conform	BU= Bulk Ware
	J= Tol. 5%		N= NON ROHS conform	TY= Tray Package

THT Radial Extremely High Current	
Part No.:	S10R46
Customer:	

DRW:	Jason	CHKD	Jules	MATL:	Wu	DATE	18.05.2009
APPD:	Join			FINISH	Shieh	Sheet	2 from 2

