



## Technical Specification

### Features

Wire Wound Construction  
 High Saturation Material  
 Polyolefin Shrink Tubing  
 Low DC Resistance  
 High Reliability

### Applications

Switching Regulators  
 RFI Suppression Filters  
 SCR and TRIAC Controls Systems  
 Automotive Systems  
 Filters

### Electrical Schematic



### Dimensions

A (mm)	B (mm)	P (mm)	E (mm)
50,80	38,10	12,70	2,54
F (mm)	C (mm)	D (mm)	
6,35	34,55	1,37	

### Dimensions

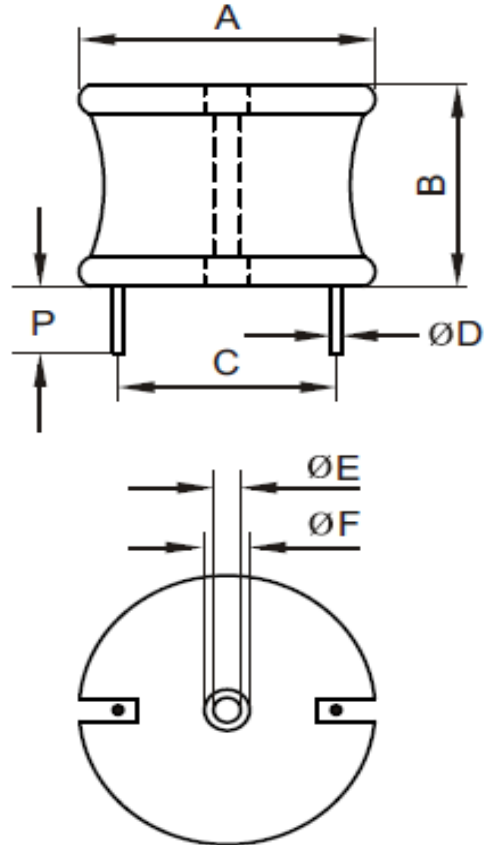

## Electrical Characteristics

### Technical Information

Testing LCR Bridge, measured @ 1KHz 0,1V HP4284A  
 Equivalent acceptable  
 RDC. QuadTech 1880 Milliohm meter  
 IDC: Max. Lowers inductance by 10%  
 Operating Temperature: -40°C ~ +85°C  
 Storage Temperature: -40°C ~ +125°C  
 Solder Methods: Vapor Phase, Infrared Reflow  
 Marking: Inductance and tolerance  
 Note: All specifications subject to change without notice.  
 Moisture Resistance: L/L 10%

Inductance	Inductance Code	IDC	DCR max.
1200µH	122	9,0A	0,1560Ω

### THT Radial Extremely High Current

Part No.: **S10R46**

Customer:

DRW:	Jason	CHKD	Jules	MATL:	Wu	DATE	18.05.2009
APPD:	Join			FINISH	Shieh	Sheet	1 from 2

Copyright by EDCON-COMPONENTS H.Schmitt 20.6.2008



**Soldering Profile**

**Classification Reflow Profile (JEDEC J-STD-020C)**



**Ordering Information**

Serie	Inductance	Tolerance	No Function	ROHS	Packing
<b>S10R46</b>	<b>122</b>	<b>K</b>	<b>0</b>	<b>R</b>	<b>BU10</b>

<b>122=</b> 1200µH	<b>K=</b> Tol. 10%	<b>0=</b> No function	<b>R=</b> ROHS conform	<b>BU=</b> Bulk Ware
	<b>J=</b> Tol. 5%		<b>N=</b> NON ROHS conform	<b>TY=</b> Tray Package

<b>THT Radial Extremely High Current</b>	
Part No.:	<b>S10R46</b>
Customer:	

DRW:	Jason	CHKD	Jules	MATL:	Wu	DATE	18.05.2009
APPD:	Join			FINISH	Shieh	Sheet	2 from 2

