



Technical Specification

Features

- Wire Wound Construction
- High Saturation Material
- Polyolefin Shrink Tubing
- Low DC Resistance
- High Reliability

Applications

- Switching Regulators
- RFI Suppression Filters
- SCR and TRIAC Controls Systems
- Automotive Systems
- Filters

Electrical Schematic



Dimensions

A (mm)	B (mm)	P (mm)	E (mm)
40,64	36,83	12,70	2,54
F (mm)	C (mm)	D (mm)	
6,35	28,96	0,89	

Dimensions

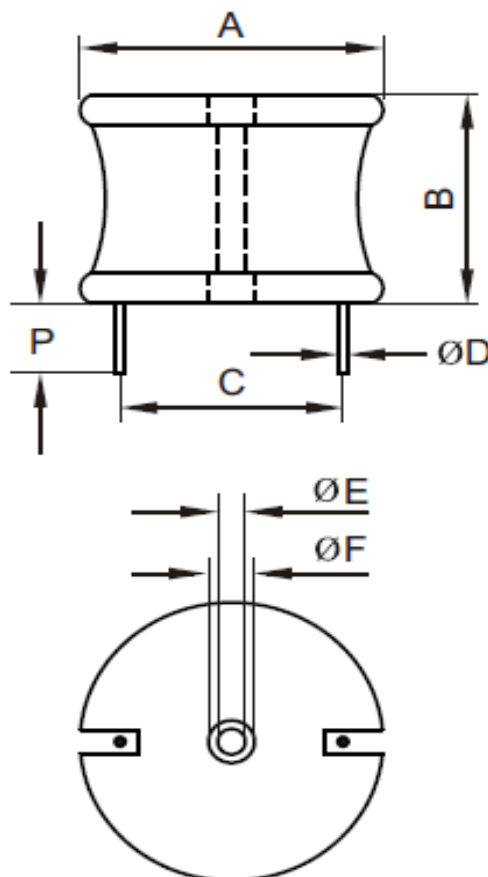

Electrical Characteristics

Technical Information

Testing LCR Bridge, measured @ 1KHz 0,1V HP4284A
 Equivalent acceptable
 RDC. QuadTech 1880 Milliohm meter
 IDC: Max. Lowers inductance by 10%
 Operating Temperature: -40°C ~ +85°C
 Storage Temperature: -40°C ~ +125°C
 Solder Methods: Vapor Phase, Infrared Reflow
 Marking: Inductance and tolerance
 Note: All specifications subject to change without notice.
 Moisture Resistance: L/L 10%

Inductance	Inductance Code	IDC	DCR max.
5600µH	562	4,0A	0,8430Ω

THT Radial Extremely High Current

Part No.: **S10R44**
 Customer:

DRW:	Jason	CHKD	Jules	MATL:	Wu	DATE	18.05.2009
APPD:	Join			FINISH	Shieh	Sheet	1 from 2



Soldering Profile

Classification Reflow Profile (JEDEC J-STD-020C)



Ordering Information

Serie	Inductance	Tolerance	No Function	ROHS	Packing
-------	------------	-----------	-------------	------	---------

S10R44	562	K	0	R	BU10
---------------	------------	----------	----------	----------	-------------

562= 5600µH	K= Tol. 10%	0= No function	R= ROHS conform	BU= Bulk Ware
	J= Tol. 5%		N= NON ROHS conform	TY= Tray Package

THT Radial Extremely High Current	
Part No.:	S10R44
Customer:	

DRW:	Jason	CHKD	Jules	MATL:	Wu	DATE	18.05.2009
APPD:	Join			FINISH	Shieh	Sheet	2 from 2

