



### Technical Specification

#### Features

Wire Wound Construction  
 High Saturation Material  
 Polyolefin Shrink Tubing  
 Low DC Resistance  
 High Reliability

#### Applications

Switching Regulators  
 RFI Suppression Filters  
 SCR and TRIAC Controls Systems  
 Automotive Systems  
 Filters

#### Electrical Schematic



#### Dimensions

A (mm)	B (mm)	P (mm)	E (mm)
40,64	36,83	12,70	2,54
F (mm)	C (mm)	D (mm)	
6,35	28,19	1,73	

#### Dimensions

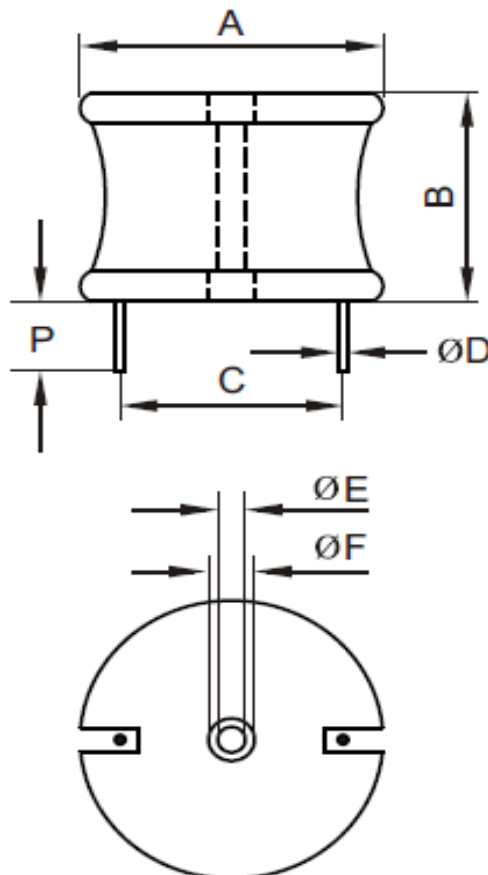

#### Electrical Characteristics

#### Technical Information

Testing LCR Bridge, measured @ 1KHz 0,1V HP4284A  
 Equivalent acceptable  
 RDC. QuadTech 1880 Milliohm meter  
 IDC: Max. Lowers inductance by 10%  
 Operating Temperature: -40°C ~ +85°C  
 Storage Temperature: -40°C ~ +125°C  
 Solder Methods: Vapor Phase, Infrared Reflow  
 Marking: Inductance and tolerance  
 Note: All specifications subject to change without notice.  
 Moisture Resistance: L/L 10%

Inductance	Inductance Code	IDC	DCR max.
330µH	331	13,5A	0,0490Ω

#### THT Radial Extremely High Current

Part No.: **S10R44**

Customer:

DRW:	Jason	CHKD	Jules	MATL:	Wu	DATE	18.05.2009
APPD:	Join			FINISH	Shieh	Sheet	1 from 2



**Soldering Profile**

**Classification Reflow Profile (JEDEC J-STD-020C)**



**Ordering Information**

Serie	Inductance	Tolerance	No Function	ROHS	Packing
-------	------------	-----------	-------------	------	---------

<b>S10R44</b>	<b>331</b>	<b>K</b>	<b>0</b>	<b>R</b>	<b>BU10</b>
---------------	------------	----------	----------	----------	-------------

<b>331=</b> 330µH	<b>K=</b> Tol. 10%	<b>0=</b> No function	<b>R=</b> ROHS conform	<b>BU=</b> Bulk Ware
	<b>J=</b> Tol. 5%		<b>N=</b> NON ROHS conform	<b>TY=</b> Tray Package

<b>THT Radial Extremely High Current</b>	
Part No.:	<b>S10R44</b>
Customer:	

DRW:	Jason	CHKD	Jules	MATL:	Wu	DATE	18.05.2009
APPD:	Join			FINISH	Shieh	Sheet	2 from 2

