



### Technical Specification

#### Features

Wire Wound Construction  
High Saturation Material  
Poleolefin Shrink Tubing  
Low DC Resistance  
High Reliability

#### Applications

Switching Regulators  
RFI Suppression Filters  
SCR and TRIAC Controls Systems  
Automotive Systems

#### Electrical Schematic



#### Dimensions

C (mm)	D (mm)
28,44	0,73

#### Dimensions

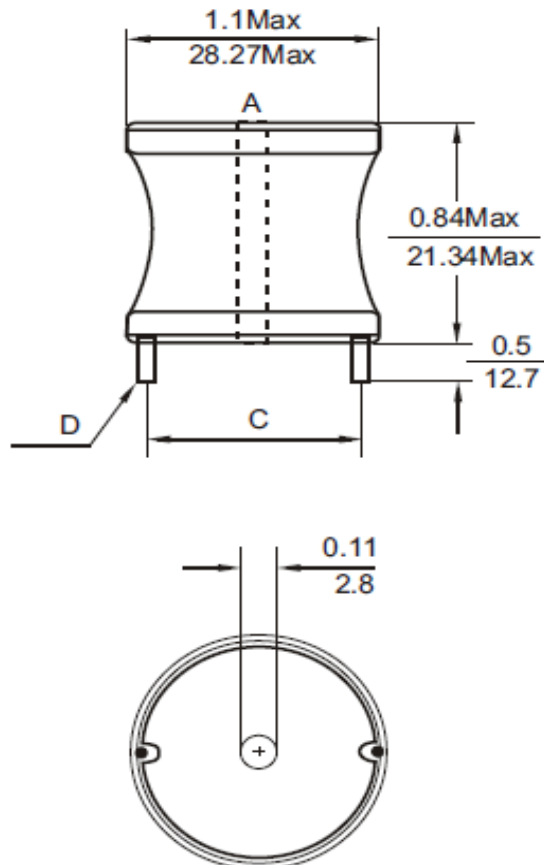

### Electrical Characteristics

#### Technical Information

Testing LCR Bridge, measured @ 1KHz 0,1V HP4284A  
Equivalent acceptacle  
RDC. QuadTech 1880 Milliohmmeter  
Rated Current: L value drop 10% typ. At Idc against  
the initial value Temperature rise 40 Max. Referrence  
ambient temperature  
Solderability: 75% of the lead wire shall be covered  
Solder Methods: Wave, Reflow  
Operating Temperature: -40°C ~ +85°C  
Storage Temperature: -40°C ~ +125°C  
Marking: Inductance and tolerance  
Moisture resistance: L/L 10% Q/Q 25%  
Note: All specifications subject to change without  
notice.

Inductance	Inductance Code	IDC	DCR max.
4700µH	472	2,0A	1,140Ω

#### THT Radial Extremely High Current

Part No.: **S10R40**

Customer:

DRW:	Jason	CHKD	Jules	MATL:	Wu	DATE	16.05.2009
APPD:	Join			FINISH	Shieh	Sheet	1 from 2



**Soldering Profile**

**Classification Reflow Profile (JEDEC J-STD-020C)**



**Ordering Information**

Serie	Inductance	Tolerance	No Function	ROHS	Packing
-------	------------	-----------	-------------	------	---------

<b>S10R40</b>	<b>472</b>	<b>K</b>	<b>0</b>	<b>R</b>	<b>BU10</b>
---------------	------------	----------	----------	----------	-------------

<b>472=</b> 4700µH	<b>K=</b> Tol. 10%	<b>0=</b> No function	<b>R=</b> ROHS conform	<b>BU=</b> Bulk Ware
	<b>J=</b> Tol. 5%		<b>N=</b> NON ROHS conform	<b>TY=</b> Tray Package

<b>THT Radial Extremely High Current</b>	
Part No.:	<b>S10R40</b>
Customer:	

DRW:	Jason	CHKD	Jules	MATL:	Wu	DATE	16.05.2009
APPD:	Join			FINISH	Shieh	Sheet	2 from 2

