



Technical Specification

Features

Wire Wound Construction
High Saturation Material
Poleolefin Shrink Tubing
Low DC Resistance
High Reliability

Applications

Switching Regulators
RFI Suppression Filters
SCR and TRIAC Controls Systems
Automotive Systems

Electrical Schematic



Dimensions

C (mm)	D (mm)
13,46	1,14

Dimensions

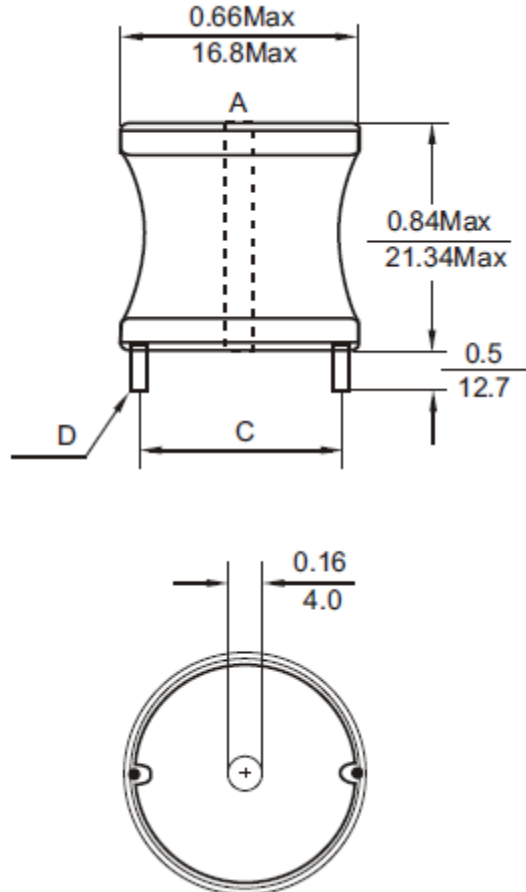

Electrical Characteristics

Technical Information

Testing LCR Bridge, measured @ 1KHz 0,1V HP4284A
Equivalent acceptacle
RDC. QuadTech 1880 Milliohmmeter
Rated Current: L value drop 10% typ. At Idc against
the initial value Temperature rise 40 Max. Reference
ambient temperature
Solderability: 75% of the lead wire shall be covered
Solder Methods: Wave, Reflow
Operating Temperature: -40°C ~ +85°C
Storage Temperature: -40°C ~ +125°C
Marking: Inductance and tolerance
Moisture resistance: L/L 10% Q/Q 25%
Note: All specifications subject to change without
notice.

Inductance	Inductance Code	IDC	DCR max.
22μH	220	5,5A	0,020Ω

THT Radial Extremely High Current	
Part No.:	S10R37
Customer:	

DRW:	Jason	CHKD	Jules	MATL:	Wu	DATE	12.05.2009
APPD:	Join			FINISH	Shieh	Sheet	1 from 2



Soldering Profile

Classification Reflow Profile (JEDEC J-STD-020C)

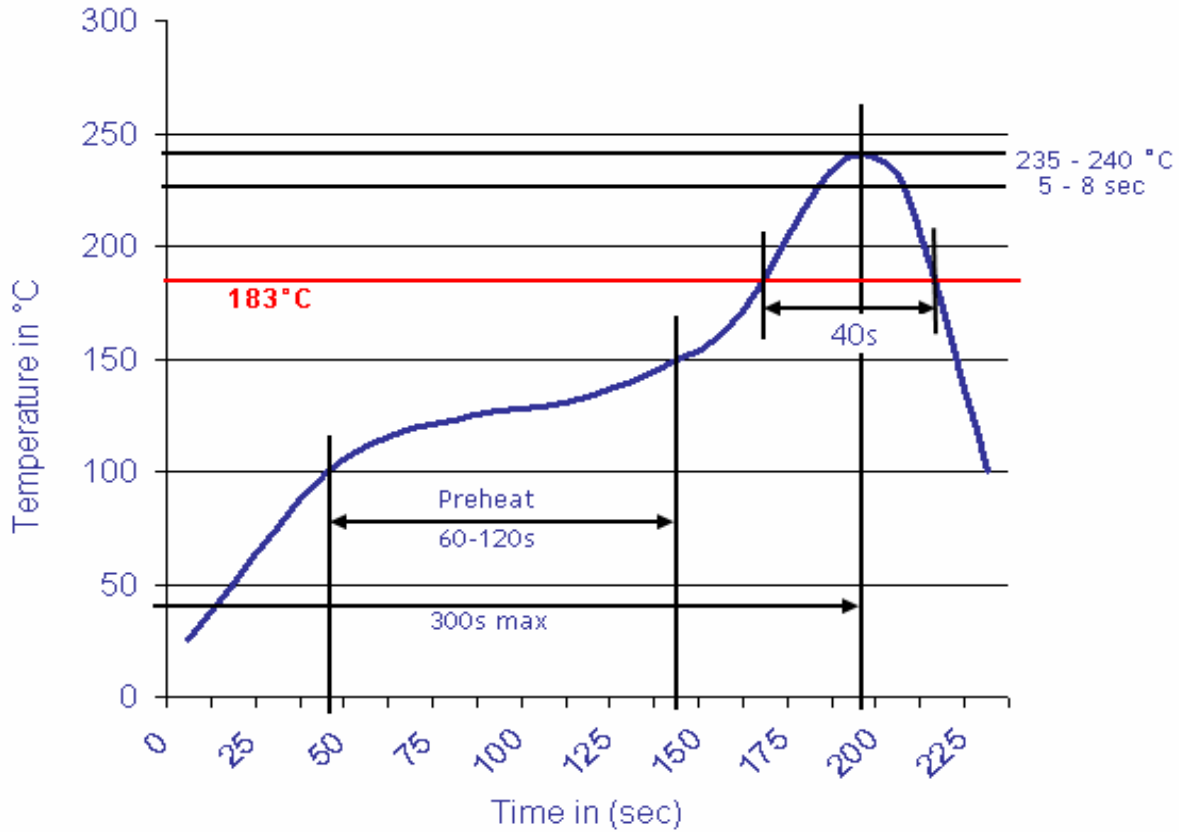

Ordering Information

Serie	Inductance	Tolerance	Function	ROHS	Packing
S10R37	220	K	0	R	BU10

220= 22µH	K= Tol. 10%	0= No function	R= ROHS conform	BU= Bulk Ware
	J= Tol. 5%		N= NON ROHS conform	TY= Tray Package

THT Radial Extremely High Current	
Part No.:	S10R37
Customer:	

DRW:	Jason	CHKD	Jules	MATL:	Wu	DATE	12.05.2009
APPD:	Join			FINISH	Shieh	Sheet	2 from 2

